



ELECTRIC SERVICE AND METERING REQUIREMENTS

INTRODUCTION

This handbook is provided by KUA as a guide for use by customers, electrical contractors, engineers, architects, and local inspection authorities. The specifications and procedures in this handbook are subject to change without notice. Therefore, communication between the user and KUA is essential in all circumstances. The following page provides the user contacts within KUA.

If items in this handbook fall short of the most recent National Electric Code (NEC) or local inspecting authority standards, the NEC and/or local standards shall prevail. However, KUA reserves the right to exceed the NEC and local authority standards on installations that it serves.

Under no circumstances is compliance with the information contained within this handbook to relieve the user of his/her responsibility for compliance with all applicable codes or safety standards.

Electric service will not be energized until:

1. Specifications and requirements are met.
2. A contract for electric service has been made.
(Call KUA Customer Service at (407) 933-9800)
3. The electric service has passed local authority inspection and KUA has been notified by that authority.

If KUA turns down the service (does not install meter), KUA will leave a door hanger onsite indicating the reason why a meter was not installed. The Owner/Contractor is required to fix installation issues.

TELEPHONE DIRECTORY

OPERATIONS (407) 933-7777 ext. 6600
engineering@kua.com

LINE OPERATIONS (407) 933-7777 ext. 6604

METER SHOP (407) 933-7777 ext. 6417

WAREHOUSE (407) 933-7777 ext. 6781

CUSTOMER/COMMERCIAL SERVICE (407) 933-9800
csr@kua.com

ENERGY CONSERVATION AND RENEWABLES *kuagreenteam@kua.com*

POWER OUTAGES/DAMAGED EQUIPMENT (407) 933-9898

OSCEOLA COUNTY 911 ADDRESSING (407) 742-5911

INSPECTION AUTHORITIES

City of Kissimmee (407) 518-2597

Osceola County (407) 742-0200

SUNSHINE STATE ONE CALL (800) 432-4770

GUIDELINES & PROCEDURES

New Construction Checklist Overview

GENERAL: In order to better address your specific project, KUA minimum requirements to further evaluate the prospective project at hand are as follows:

SINGLE FAMILY RESIDENCE: If your project is a single family residence on an already platted lot, the following items will need to be provided or be addressed.

- A. A copy of platted lot survey showing survey boundaries and applicable utility easements.
- B. If the electric service main is greater than 200 amps, a load sheet form will need to be filled out.
- C. Provide information on the square footage of the proposed dwelling.
- D. Utility easements are required for any facilities that KUA has to put on a piece of property. This recorded utility easement must be signed and returned to KUA before the electric meter will be installed. Refer to the document labeled utility easement instructions.
- E. Underground conduit is required for most applications arising to metered services. The owner shall install all conduits as per KUA's specifications.
- F. Where KUA has to install pad-mount transformers and/or secondary junction boxes, a final grade sheet form will need to be signed and returned before any electric infrastructure is energized.
- G. No electric meter will be allowed behind any single family dwelling. All service locations must be on the side of each dwelling and be per KUA's underground installation requirements and other applicable documents.
- H. Prior to actual need for Temporary or Permanent Power, the person responsible for paying the utility bill must make application for

service, including a utility deposit, through the KUA Customer Service Department.

Upon recipient of information regarding your project is received, it could take up to three weeks to provide a project estimate. The project drawing for single family resident projects will not be released for construction scheduling until all payments to the applicable line extension contract has been made and the related utility easements have been addressed.

SUBDIVISION CONSTRUCTION: If your project is a subdivision or a multi-unit dwelling, the following items will either need to be provided or addressed.

- A. A digital AutoCAD drawing file (.DWG) of geometric site plan. Must include all necessary referenced files (xref). A pdf file and paper copy of the geometric site plan must also be submitted. Any version of AutoCAD from 2000 to 2019 are acceptable versions.
- B. Preliminary plat in a final plat format for subdivisions including road names & border (preliminary plat must match drawing supplied in digital form). AutoCAD drawing file, a pdf file, and paper copy of this plat will need to be submitted.
- C. A commercial load sheet must be supplied for all commercial facilities such as club houses, gazebos, lift stations, etc. A paper copy of the electrical riser diagram of such facilities will also need to be submitted.
- D. Information on the square footage of proposed single family and/ or multi-family dwelling types and the electric service main of each dwelling type will also need to be submitted.
- E. A paper copy of the water and sewer plans, landscaping, subdivision wall structures, and other associated utility plans will need to be submitted.
- F. Plats/plans are required to design the construction of the electric lines, transformers, etc., specific to your project. The provided plat/plan must show utility easements as requested by KUA. The customer will be required to provide KUA with a final recorded plat including required utility easements prior to any meters being set. (Exception: Model homes in a city subdivision). All other descriptive easements must be submitted to KUA for recording before KUA facilities are installed. All electric infrastructure conduit underneath private roads will require a descriptive 10 ft. utility easement.

- G. Underground conduit is required. The developer shall install all conduits as per KUA's specifications. Before closing the excavation, the developer will request inspection by KUA, whose representative shall be the sole judge of the adequacy of the installation.
- H. All street lights that may need to be installed in the proposed subdivision may require either a street lighting contract per the COK land development code or KUA's lighting service agreement. If a photometric lighting layout is needed, it is the responsibility of the developer to have such document produced and then KUA will lay out the proposed lighting accordingly.
- I. Developer Responsibility Form and Final Grade Sheet form are required to be signed and returned before any electric infrastructure facilities are energized.
- J. A preliminary construction schedule regarding the energizing of specific sections of the phase will need to be provided.
- K. No electric meter services will be allowed behind any single family or multi-family dwellings. All service locations must be on the side of each dwelling and be per KUA's underground installation standards requirements as stated in said document.
- L. **Metering of Separate Occupancy Units.** KUA follows Florida Public Service Commission Rule 25.6049 as a guideline. Rule 25.6049 requires that individual electric metering by utilities shall be required for each separate occupancy unit of new commercial establishments, residential buildings, condominiums, cooperatives, marinas, and trailer, mobile home and recreational vehicle parks. This requirement also applies to changes of use in which a commercial customer changes the character of its use from non-residential use to residential use with separate occupancy units (see Osceola County Ordinance 2021-78).
- M. Submittal of the corporate name, address, and contact information in which the line extension contract and other related documents are to be made out to will also need to be submitted.

N. Prior to actual need for Temporary or Permanent Power, the person responsible for paying the utility bills must make application for Residential or Commercial Service, including a utility deposit, through the KUA Customer Service Department. Before the contractor can requests TUGs, 911 addressing must be submitted.

Upon recipient of information regarding your project is received, it could take up to eight (8) weeks to provide a project estimate. The project drawing for subdivision projects will not be released for construction scheduling until all payments to the applicable line extension contract has be made and the related utility easements have been addressed.

COMMERCIAL CONSTRUCTION: If your project is a commercial parcel, the following items will either need to be provided or addressed.

- A. AutoCAD drawing file (.DWG) of geometric site plan (digital). Must include all necessary referenced files (xref). A pdf file and paper copy of the geometric site plan must also be submitted. Any version of AutoCAD from 2000 to 2019 are acceptable versions.
- B. Preliminary plat in a final plat format (if applicable) including road names (preliminary plat must match drawing supplied in digital form). AutoCAD drawing file, a pdf file, and paper copy of this plat will need to be submitted.
- C. Construction plans for multi-family or commercial buildings with detailed geometric site plan including road names (must match drawing supplied). Hard copy or pdf files.
- D. Commercial electrical riser diagram. Hard copy only.
- E. Commercial Load Information Sheets: Required for proper transformer sizing. This form can be found on the internet at www.kua.com. Please select Builders/KUA Load Information.
- F. Water and sewer plans or other associated utility plans. Hard copy only.
- G. Plats/plans are required to design the construction of the electric lines, transformers, etc., specific to your project. The provided plat/plan must show utility easements as requested by KUA. The customer will be required to provide KUA with a final recorded plat including required utility easements prior to any meters being set. All other easements must be submitted to KUA for recording before KUA facilities are installed.
- H. Underground conduit is required. The developer shall install all conduits as per KUA's specifications. Before closing the excavation, the developer will request inspection by KUA, whose representative shall be the sole judge of the adequacy of the installation.
- I. All area lighting to be leased by KUA will need to be addressed at the beginning of the project. Once a particular style is chosen a lighting service agreement will need to be signed by the property owner. If a

photometric lighting layout is needed, it is the responsibility of the developer to have such document produced and then KUA will lay out the proposed lighting accordingly.

- J. Developer Responsibility Form and Final Grade Sheet form are required to be signed and returned before any electric infrastructure facilities are energized.
- K. A preliminary construction schedule regarding the energizing of specific sections of the phase will need to be provided.
- L. Prior to actual need for Temporary or Permanent Power, the person responsible for paying the utility bills must make application for Commercial Service, including a utility deposit, through the KUA Customer Service Department.

Upon recipient of information regarding your project is received, it could take up to six (6) to twelve (12) weeks to provide a project estimate depending on the size of such development. The project drawing for projects will not be released for construction scheduling until all payments to the applicable line extension contract has been made and the related utility easements have been addressed.

GUIDELINES & PROCEDURES

Facility Connection Requirements

PREFACE: This information herein is not intended to conflict with the National Electric Safety Code, the National Electric Code, or such state or local laws or ordinances as may be in force in the KUA Service Territory. The following guidelines are KUA requirements at the date indicated on the first page of this document. KUA should be contacted for the latest requirements in effect.

INTRODUCTION: The information herein provided by the Kissimmee Utility Authority (KUA) for the guidance to customers, developers, contractors, engineers, and electricians who are planning electrical installations for residential and commercial installations. When planning large commercial establishments, it is necessary that KUA Engineering & Operation Department be contacted and the respective detailed project material be submitted on the anticipated service requirements.

Concerns: Safety and reliability for both the public and KUA's personnel is a major concern when laying out infrastructure. Therefore, such information regarding wall locations, tree requirements, swells, elevation changes, and other known obstacles need to be identified to KUA in order to provide the customer/developer the electric infrastructure design for their project. Further KUA requirements may be required depending on the specific project location and layout.

Compliance with these requirements does not absolve the customer/developer from the obligation to install and maintain wiring and equipment in a safe condition. KUA does not accept any responsibility for the quality or condition of the customer's wiring or equipment.

DEFINITIONS: Words, phrases, or other expressions used herein this document shall have the following meanings.

"KUA": Kissimmee Utility Authority acting through its Board of Directors and their duty authorized personnel.

"Property owner, developer, business, customer, or customer premise": The residential or commercial occupant who buys electric power from KUA.

“Commercial Service”: Service to Customers engaged in selling, warehousing, or distributing a commodity in some business activity or in a profession, or in some form of economic or social activity (offices, stores, clubs, hotels, schools, etc.)

“Residential Service”: Service to customers in private residences and individually metered apartments and condominiums when all energy is used for domestic purposes.

“Subdivision”: A parcel of land which is subdivided into tracts or lots or more building lots or upon which more than one (1) separate dwelling units are to be located, or land on which new multiple-occupancy buildings are constructed.

“Conduit”: The electric gray pipe of either Schedule 40 PVC, Schedule 80 PVC, Galvanized Steel, HDPE, or Restrained Joint PVC.

“Conduit Inspector”: KUA’s employee who will inspect the conduit installation to make sure it is in compliance with the requirements outlined in the various applicable KUA documents.

“Locator”: Either a KUA employee or other utility employee whose job is to identify in the field the approximate locations of existing facilities.

“Meter can or meter socket”: The housing that holds the electric meter in place and is affixed to the building facing.

“Capacity Requirements”: The maximum voltage and current needs of a Customer or his facility.

“Underground (UG) Primary”: The underground electric infrastructure that operates at a 13,200 volts and hasn’t been stepped down yet via a transformer for customer consumption.

“Underground (UG) Secondary”: The underground electric infrastructure that has been stepped down via a transformer for customer usage. Such secondary voltages are 120/240 volt, 120/208 volt, or 277/480 volt.

“Transformer”: The electric device installed and owned by KUA that steps the voltage down from 13.2 kilovolts to a secondary voltage type.

“Primary junction box or secondary junction box”: A fabricated box that KUA installs on a pedestal for terminating UG primary or UG secondary wires.

“Hand hole”: A sub-surface box in which conduit is stubbed up into for terminating underground secondary wires.

“Easement or Utility Easement”: A privately owned parcel of land which is dedicated by the Owner for the primary purpose of installing, maintaining and replacing KUA’s facilities.

“Final Grade or Finished Grade”: The final grade level of the earth around a building, or structure, and within the utility easement.

GENERAL REQUIREMENTS: Electric Service Availability and Characteristics: When planning out a particular project, it is important to provide KUA with the anticipated service main size, connected electrical load, and the anticipated secondary voltage needed. Such voltage types available are 120/240v, 3 wire single phase, 120/240v 4 wire three phase, 120/208v 4 wire three phase, and 277/480v 4 wire three phase. All of the above voltages are supplied at approximately 60 hertz. An electrical load sheet must be filled out. This electrical load sheet can be acquired either on-line at KUA.com or in person.

Since the voltage and the number of phases depend upon the characteristics of the electric load; as well as, its size and location, it is necessary for the customer/developer to consult KUA regarding the type of service needed before proceeding with the purchase of any equipment or wiring installation.

All service requested by the customer shall be metered for energy consumption, except for dusk to dawn KUA leased lighting and other special services covered under KUA’s tariff sheets. Commercial customers, depending on load, may require demand and reactive metering.

APPLICATION FOR ELECTRIC SERVICE: Application for electric service to either a new installation, or a revision of service for an existing installation, must be made with KUA Customer Service Department. It is important to contact KUA as far in advance as possible of the anticipated service date so that potential issues can be addressed beforehand. First, contact KUA’s Customer Service Department with your service needs and they will determine if personnel from Engineering & Operations Department need to further consult with you.

LINE EXTENSION: In order to avoid delay, the customer/developer desiring electric service must inquire with KUA as to what type service may be provided, and make necessary arrangements before starting site work.

When the customer/developer requests KUA to deliver energy in a manner or location away from existing infrastructure, line extension cost may be applicable.

Commercial and Subdivision developers are urged to consult with KUA as soon as preliminary plans are made, in order that the electric line extensions may be developed for the best possible arrangement, and utility easements can be recorded before any lots are sold.

INFRASTRUCTURE REQUIREMENTS: For commercial development and subdivision development, it is the intent of KUA to design the electric infrastructure route that is most optimal to the site design layout to provide reliability. Therefore, the electric infrastructure location and routing must be installed per the site conduit layout provide by KUA’s Engineering and Operations Department. Routing of all underground infrastructure will require a means of looping whether for one transformer or many. Looping may be accomplished by tying all the primary together throughout the project or by having additional conduit install for future growth in the area to create an eventual loop configuration. Where applicable, KUA’s designer will chose the most optimum route available based on the terrain and obtainable utility easements. Future spare conduits may also be required when projects are built out in phases.

DOCUMENT SUBMITTALS TO KUA: It is important that the construction personnel related to such commercial development and/or subdivision development obtain all document related to the installation of KUA’s electric infrastructure. Such applicable documents may consist of (1) conduit crossing plans, (2) conduit layout plans, (3) this document, and (4) KUA’s underground standards requirements.

VARIOUS GOVERNMENTAL ENTITIES REQUIREMENT THAT AFFECT KUA

INFRASTRUCTURE LAYOUT: Note that most electric infrastructure to such project site will be underground due to the requirements of the City of Kissimmee Land Development Code Requirements and Osceola County Land Development Code Requirements. When working in the right-of-way, there are times in which such governmental entity will require infrastructure to be installed deeper than KUA’s standard requirements.

INSTALLATION AND RESPONSIBILITY – STRUCTURE SPECIFIC: It is necessary of the customer that all work, wiring and apparatus be installed and maintained in a safe manner by a licensed electrician or qualified party. The customer, in accepting service from KUA, assumes full responsibility for all the safety of the wiring and apparatus which the customer installs.

INTERFERENCES TO KUA’S ELECTRICAL SYSTEM: The customer shall not operate any apparatus which creates a condition that interferes with KUA’s operation and prevents KUA from supplying satisfactory service to the customer or to other customers. This condition includes, but is not limited to, operating equipment that interferes with the satisfactory operation of other customer’s radio, television and communication equipment.

KUA reserves the right to place restrictions on the type and manner of use of all the customer’s electrical equipment which is connected to KUA’s lines, especially prohibiting any large loads of highly fluctuating or low power factor characteristics.

INSPECTION REQUIREMENTS: The customer is responsible for obtaining inspections on work done to their electrical system as required by the City Building Department and Osceola County Building Department. Where the customer puts electric facilities such as for a sign or lighting within the right-of-way, a right-of-way utilization permit is required by the City or Osceola County. Contact the respective Public Works Departments for specific requirements. Where electric conduit is required for use in KUA’s infrastructure, conduit inspection is required. Refer to the Conduit Standards section of this manual.

ALTERATIONS AND ADDITIONS TO INDIVIDUAL METERED SERVICE: KUA’s facilities used to provide service have definite capacity limitations and can be damaged by overloads. Therefore, the customer must notify KUA before making alterations to the service entrance equipment so that facilities of the proper capacity may be provided. The customer is responsible for all expenses and/or damages to customer’s facilities resulting from failure to give proper notice. The customer may also be subject to charges by KUA for the work required to meet the customer’s alteration.

ALTERATIONS TO OCCUPANCY TYPE. As previously stated, KUA follows Florida Public Service Commission Rule 25.6049 as a guideline. If alteration or renovation is planned to change the character of a facility, building, or space’s use from non-residential use to residential use with separate occupancy units (*see Osceola County Ordinance 2021-78*), then the customer must notify KUA before making the alterations. The facility’s metered service must be changed from an individual metered service to a ganged metered service with a separate meter provided for each residence. The customer is responsible for all alteration expenses to the facility’s electrical

system beyond the ganged metered service. The customer may also be subject to charges by KUA for the work required to meet the customer's alteration.

ALTERING OR COVERING KUA EQUIPMENT. The permanent alteration, modification, wrapping, covering, or coating of KUA equipment by customers, developers, and other third parties is strictly and uniformly prohibited. This prohibition is enforced to maintain the safety, reliability, warranty, and operational functionality and maintainability of KUA equipment. Temporary shielding of equipment by contractors to protect it from nearby construction activities may be required at the sole direction of KUA. At KUA'S sole discretion, KUA may allow wrapping of its equipment by Municipality or County Government entities upon request provided that KUA is satisfactorily indemnified and held harmless for such installation. Such Government installation shall be subject to basic safety and operational limitations.

CUSTOMER OWNED STRUCTURES NEAR OVERHEAD POWER LINES:

Structures, including signs, flagpoles, privately owned light poles, antennas, or aerials shall not be installed under, over, or in such close proximity to lines carrying electric current that they could be raised into, or fall onto such lines or that they cannot be safely maintained. Antennas or aerials shall not be attached to KUA's poles or any pole used in supplying electric service to the customer. Vertical and horizontal clearance from energized facilities to such structures are governed by the National Electric Safety Code (NESC). Consult KUA for clearance requirements.

KUA'S PERSONNEL ACCESS TO CUSTOMER'S PREMISES: KUA's employees shall have access to the customer's property, during reasonable hours for the purposes of supplying and maintaining service and equipment. Upon termination of service, KUA shall be permitted to remove any such property. Authorized KUA employees visiting the premises for any reason will carry proper KUA identification. The customer may refuse admission to person not having proper identification.

UNDERGROUND ELECTRICAL SERVICE REQUIREMENTS: KUA's standard method of service is underground. Underground service is available to individual customers; as well as, developments provided certain required conditions are satisfied. Depending on the application, the point of service for underground feeds vary. For single family residential services, the point of service is the meter can location in which the secondary wire from the transformer/secondary box to the meter can is furnished, installed, maintained, and owned by KUA. While for commercial services and gang metered multi-family residential services, the point of service is the transformer/secondary box. Therefore, it is the responsibility of the owner/developer to furnish, install, and maintain the electric service conduit and conductor.

SERVICE POINT LOCATION IDENTIFIED: For all underground services, KUA will designate the location for the service point to the building or in some cases a service point remote from the building to which the customer/developer must bring his service conductors. KUA will assume no responsibility for changing the location of the service conductor if an improper location is chosen without consultation with KUA or if the previously designed location is not utilized.

In order to comply with requirements of governmental entities, if it becomes necessary for KUA to make changes in the location of its equipment or to change the character of its service, the customer will, at his expense, make such changes.

SIZING OF ELECTRIC SERVICE EQUIPMENT: The use of properly rated service equipment is required for all underground service installations. Due to the difficulty involved in later increasing the size of underground installations to provide for increased loads, it is especially important that they be made large enough for the expected future increase in load. Service entrance equipment shall not be installed in any location that is likely to become obstructed or inaccessible, and should be installed in a location that will not be used for any other purpose. Conductors shall be in accordance with code requirements for this type of application. For all metered services, KUA will make connections on the line side of the meter socket and the customer/developer shall make connections on the load side of the meter socket.

GUIDELINES & PROCEDURES

Electric Metering Service Requirements

PREFACE: This information herein is not intended to conflict with the National Electric Safety Code, the National Electric Code, or such state or local laws or ordinances as may be in force in the KUA Service Territory. The following guidelines are KUA requirements.

Reference Standards: All work associated with the installing or retrofitting of a meter service shall conform to the requirements of applicable codes, standards and all local agencies having jurisdiction. The published edition of the National Electric Code (NFPA-C2 – Latest Edition) and the National Electric Safety Code (IEEE C2-Latest Edition) shall be incorporated into this document as applicable to metering and vertical clearance.

DEFINITIONS: Words, phrases, or other expressions used herein this document shall have the following meanings.

“Alternating Current (AC)”: Current which alternates the direction of its flow periodically. The period in which it alternates or changes from original to reverse back from original is a cycle (frequency) measured in Hertz.

“Ampere (amp)”: Unit of measurement of current. Quantity of electrons flowing through a conductor past a given point in one second.

“Branch Circuit”: That portion of the electrical circuit nearest the utilization point behind the main disconnect and the last circuit protective device.

“Cable”: An electrical conductor composed of two or more separately insulated wires banded or twisted together.

“Circuit”: A conductor or system of conductors and other electric equipment through which electric current flows or is intended to flow.

“Circuit Breaker”: An overcurrent device used to protect wiring from excessive current flow.

“Demand”: The magnitude of electric load in operation at an installation. Demand may be expressed in kilowatts, Kilovolt-amperes, or other suitable units.

“Energy”: Electric power consumed over time, generally expressed in kilowatt-hours.

“Flicker”: The momentary variation of voltage level caused by on/off switching of a circuit load.

“Fuse”: A protective device containing a small wire designed to melt when current reaches a value that could damage the conductor for runoff or absorption of excess electrical current.

“Loop”: An electrical circuit that provides two sources of power to a load or substation. Within a loop, when a source is de-energized, the remaining source can continue to provide power.

“Ohm”: A unit of measurement of electrical resistance.

“Point of Attachment (to the customer)”: That location at which KUA attaches its service to the Customer’s wiring system.

“Point of Delivery”: The point where KUA’s facilities are connected to the service cable serving the customer.

“Resistance”: Property of substance to resist the flow of electric current. A certain amount of energy is required to overcome resistance of an electrical conductor, resulting in some energy loss.

“Service Drop”: The overhead service conductor from the last pole or other aerial support to and including the connections to the service entrance conductors at the building.

“Service Equipment”: The necessary equipment, usually consisting of circuit-breaker or switch, fuses, and their accessories, located near the point of entrance of supply conductors to a building and intended to constitute the main control and means of disconnection for the supply to that building.

“Service Lateral”: The underground service conductor between the transformer, hand hole, junction box or pole and the Customer’s terminal box, meter or other enclosure.

“Single Phase”: One phase of a three-phase system.

“Tap”: An electric circuit with limited capacity extending from the main feeder, usually supply a small number of customers.

“Three Phase”: A term applied to circuits or machines utilizing three alternating current voltages, equal in magnitude, separated by 120 electrical degrees.

“Voltage”: The electrical pressure of a circuit expressed in volts. Generally, the nominal rating based on the maximum normal effective difference of potential between the conductors of a circuit.

“Voltage Dip”: A momentary reduction of voltage level.

“Weatherhead”: A device used at the service entrance to prevent water from entering the service mast or riser.

METERING FOR ELECTRIC SERVICE: KUA will furnish the necessary meter based on the information provided regarding the type of electric service being requested by the customer. All electrical energy furnished by KUA shall be determined by the meter’s measurements. If a meter fails due to a defect not caused by the customer, adjustments will be made. KUA requires individual meters for each separate occupancy unit of commercial establishments, residential buildings, condominiums, cooperatives, marinas, mobile homes and recreational parks.

ACCESS TO KUA’S EQUIPMENT: Duly authorized agents of KUA shall at all times have access to KUA’s Equipment on the Customer’s premises for the purpose of installing, maintaining, inspecting, & removing KUA property, and shall have access to the premises during normal working hours for the purpose of meter reading. KUA shall not be liable for trespass during the performance of these activities. The customer shall grant or cause to be granted to KUA without cost to KUA, all rights, easements, permits, and privileges which in the opinion of KUA, are necessary for the rendering of service to the Customer.

SERVICE VOLTAGE AVAILABLE: It is essential that the customer consult KUA Engineering Department before proceeding with the purchase of equipment or installation of wiring. The type of service provided will be determined by KUA based on the character of the customer’s load. The following table will be used as a guide in determining the type of service for which the customer may be qualified.

Typical Service Voltage	Typical Structure Type:	Maximum Service Size:	Pull Wire
120/240v 1ph 3wire	Single Family (overhead or underground)	400A	KUA
120/240v 1ph 3wire	Townhouse (Gang meter pedestal preferred)	200A	Cust
	Townhouse (Individual run meter)	200A	KUA
	Mobile Home (on parcels zoned as a Park; ex Mobile Home Park)	200A	Cust
	Mobile Home (on parcels zoned Residential Mobile/Manufactured Home)	200A	KUA
120/208v 1 ph 3 wire from 3ph transformer	Apartment or Condominium Unit (Gang meter set up only)	200A	Cust
120/240v 3ph 4wire Delta	Overhead Service	400A	KUA
	Underground Service	800A	Cust
120/208v 3ph 3wire	Underground Service	200A	Cust
120/208v 3ph 4wire Wye	Overhead Service	400A	KUA
	Underground Service	3000A	Cust
277/480v 3ph 4wire Wye	Overhead Service	400A	KUA
	Underground Service	3000A	Cust

Cust = Customer

TEMPORARY ELECTRICAL SERVICE: KUA has special requirements for temporary service and must be consulted for each case. Installations requiring special service, meter or other work for construction purposes, exhibits for short durations, etc., shall be made at the expense of the customer.

Temporary installation for service entrance, other wiring and meters shall be made and inspected in the same manner as permanent installations. The temporary service drop or temporary construction wires shall not be tied to the customer's permanent panel except for testing purposes.

Temporary service for construction purposes may be either overhead or underground depending on the available service needs. All temporary saw poles or underground pedestals must have a driven ground. All overhead temporary poles must be 16 feet long and be at least a 4"x6" thickness. The disconnect panel must be mounted next to the temporary meter can.

Refer to the Customer Service Department fee schedule for applicable fees and deposits that may be associated with the setting up of a temporary service.

TUG PROCEDURE: Temporary underground service (TUG) is available for residential service where the permanent meter enclosure, meter and riser pipe are configured in a manner that they can be used for temporary service. Due to the fact that TUG is utilized to provide temporary service; as well as, permanent, and at the time of installation the building may not be ready to display a permanent address, the address shall be identified on the meter enclosure.

Upon receipt of the application for TUG service and approval inspection, KUA will install the permanent underground service to the meter enclosure. This service can be used for construction purposes only until the Certificate of Occupancy has been obtained. The builder/developer is responsible for having the service converted and put into the name of the homeowner.

When an electric panel is configured for a TUG, the main line switch and breakers are mounted in the panel with receptacles mounted below the panel. Upon receipt of the customer's contribution for the various fees and final inspection approval from the respective governmental entity, KUA will install the permanent underground service and meter.

Contact either the City or County building departments for the applicable TUG form that you as a developer will need to fill out before contacting KUA.

PERMANENT POWER: Permanent power is defined as the final electric service required to bring the facility to completion for occupancy. When the developer wants such service type, it is his responsibility to contact the applicable inspection agency and to establish an electric account with KUA. When the final inspection clearance and application has been received, KUA will proceed with scheduling the meter to be set.

Within subdivisions in both the City of Kissimmee and Osceola County, an underground service is required. For services 200 amps or less, a 2" gray sch-40 conduit will need to be installed from the transformer or junction box to the meter base. For services 201 amps to 400 amps, a 3" gray sch-40 conduit will need to be installed from the transformer or junction box to the meter base. The meter base height must be within a range of 48 inches to 66 inches. The depth of this conduit must be at least two (2) feet from top of conduit to final grade.

For the limited number of locations that overhead services may be required, the customer shall install a minimum of five (5) feet of service cable beyond the protective weather head in order that the required connections can be properly made by KUA. Before guessing whether an overhead service is acceptable, please contact KUA's Operations Department first.

Additional requirements may be required for your permanent meter service depending on your application, first contact KUA's Engineering Department before proceeding with any work. Other applicable documents associated with permanent electric service are the "Underground Standard Requirements" and the "Facility Connection Requirements". Refer to the Customer Service Department fee schedule for applicable fees and deposits that may be associated with the setting up of a permanent electric service.

OVERHEAD ELECTRIC SERVICE REQUIREMENTS: In areas where the existing distribution system is overhead, overhead services may be allowed. Verify with KUA's Engineering Department before building an overhead service. For overhead service drops, a minimum clearance of 36 inches above the roof is required. Installations where it is not feasible to provide a point of attachment 36 inches above the roof will require the customer to provide and install a secure point of attachment that will meet the clearance requirements of the NESC. All vertical clearances over driveways, roadways, etc., must comply with the clearance requirements of the NESC and the FDOT.

UNDERGROUND ELECTRICAL SERVICE REQUIREMENTS: KUA's standard method of service is underground. Depending on the application, the point of service for underground feeds vary. For single family residential services, the point of service is the meter can location, in this case, the secondary wire shall be furnished, installed, maintained, and owned by KUA. While for commercial services and gang metered multi-family residential services, the point of service is the transformer/secondary box. Therefore, it is the responsibility of the owner/ developer to furnish, install, and maintain the electric service conduit and conductor.

MOBILE HOME SERVICE: Overhead Service poles that feed mobile homes are considered the property of said parcel owner. The metering pole shall be at least 18 feet long so that it can be set in the ground at least 3 feet deep and be pressure treated with a CCA compound. This requirement is so that there will be at least 16.5 feet vertical clearance for the service wire and that it will be rigid enough to withstand 200 lbs. of pull at the pole top. The pole diameter shall be having a minimum circumference of 15 inches or at least be a 6" by 6" square pole.

Underground service poles shall be at least 4" by 4" concrete post. For individual or gang meter set ups on lots zoned as a Park (ex: Mobile Home Park) the secondary conduit and conductor shall be furnished and installed by the customer. For mobile homes on lots zoned Residential Mobile/Manufactured Home, the secondary conduit shall be furnished and installed by the customer while the secondary conductor will be furnished and installed by KUA.

All components such as load side conductors, conduits, conduit straps, electric disconnects, 200-amp meter socket, and mounting hardware shall be furnished and installed by the property owner. The meter socket shall be mounted in a manner that it allows the meter to be inserted and withdrawn without causing movement of the socket.

All new and replacement meter service poles and equipment must meet the requirements of the inspection agency and pass inspection before KUA will energize the service.

SERVICE POINT LOCATION IDENTIFIED: For all underground services, KUA will designate the location for the service point to the building or in some cases a service point remote from the building to which the customer/developer must bring his service conductors. KUA will assume no responsibility for changing the location of the service conductor if an improper location is chosen without consultation with KUA or if the previously designed location is not utilized.

In order to comply with requirements of governmental entities, if it becomes necessary for KUA to make changes in the location of its equipment or to change the character of its service, the customer will, at his expense, make such changes.

For all metered services, KUA will make connections on the line side of the meter socket and the customer/developer shall make connections on the load side of the meter socket.

ELECTRICAL GROUNDING: The grounded neutral conductor of the service entrance conductors shall be grounded in accordance with the NEC, latest edition. All conduits, metallic tubing, and service entrance equipment shall be grounded also in accordance with the latest edition of the NEC. KUA does not allow the installation of foreign grounding conductors within its pad-mounted switchgear and transformers or the attachment of foreign grounding conductors to its ground.

SERVICE ENTRANCE REQUIREMENTS: Wires carrying metered energy shall not be located in the same raceway with wires carrying un-metered energy. All service entrance conductors must be of sufficient size to conform to the rated ampacity of the service entrance equipment and also be of sufficient size to provide for reasonable future load increases. It is required that the neutral conductor of the service entrance wires be plainly identified. Bare or substantially white insulated wires are sufficient identification.

WIRING ALLOWED IN METER CAN: In self-contained installations, no wiring except the service entrance conductors and grounding conductors may pass through the meter socket. No wiring may pass through the instrument transformer meter socket except that installed by KUA.

WIRING TROUGHS: All wiring troughs containing un-metered wire as shall be of a lockable/sealable type. It is required that the high voltage leg and neutral of four wire delta service entrance conductors be identified in each box, cabinet, switch, or trough through which they pass. They shall also be identified at the weather head. Neutral or grounding conductors of any system must be readily identifiable.

The line side high voltage leg of a delta system should always be attached to the top right hand terminal in the meter socket. The load side high voltage leg of a delta system should be connected to the bottom right terminal of the meter socket.

GANG METER LOCATION REQUIREMENTS: For duplex buildings, condominiums, townhouses, apartment buildings, etc., separate sets of service entrance conductors must be brought out to a common point on the building wall to be connected to a single service lateral. If a building wall cannot be attached to, a permanent pedestal wall or permanent grounded stainless steel metal frame must be provided for the common point.

METERING EQUIPMENT: KUA will furnish and connect all meters, instrument transformers, and meter control wiring necessary to complete the meter installation on each project location within KUA's territory. Meters for service to residential and commercial customers shall be installed outdoors. Where building mounted CT cabinets are required, it is up to the customer to furnish and install them.

BIDIRECTIONAL METERING (NET METERING): KUA customers who install customer-owned renewable generation systems (RGS) and desire to interconnect those facilities with KUA's electrical system are required to complete an application and pay applicable fees to KUA. Customers shall also complete the appropriate Tier 1, Tier 2, or Tier 3 Interconnection Agreement and the Tri-Party Agreement prior to grid connection. All required paper work can be found at: <https://kua.com/energy-conservation-and-renewables/net-metering/>. For additional information, please email kuagreenteam@kua.com.

METERING LOCATION – GENERAL: The meter location is an important consideration for both the customer and KUA. If there are any obstacles that affect where the meter can be placed, please inform the KUA designer so he can incorporate it into his design. Meter sockets and enclosures shall be securely mounted in a plumb and level position on a solid wall or structure. The customer shall be responsible for securely fastening the meter enclosure in order to withstand the normal forces required to routinely remove and install the meter. Meter enclosures shall not be recessed or framed in any way that blocks access, knockouts, or drainage.

METER LOCATION – RESIDENTIAL: Meters for single family residential homes shall always be located outdoors and shall normally be on the front half of a side wall, and shall not be enclosed by a fence. Refer to KUA's conduit layout plan for the specific subdivision to determine which side of the house that the meter service is to be located. Meters shall not be located in areas such as carports, open porches, swimming pools, etc., which are susceptible to subsequent enclosures by walls or screens. In the event a meter area is later enclosed or otherwise made inaccessible or unsafe, the customer shall, at his expense, have the meter facilities moved to a readily accessible outside location.

METER LOCATION – OUTDOOR COMMERCIAL: Commercial metering shall normally be installed outdoors. Meters shall be located on a building in a place where they shall be protected from mechanical damage. The location should not be affected by a kitchen discharge fan or other vents, or the drain from a roof gutter or air conditioner and should be free from vibration. The customer is responsible for providing this protection. On new construction, the center of the meter shall not be more than 5.5 feet maximum or less than 4 feet minimum from the final grade or floor. A clear space of at least 48 inches from the front of all meter enclosures shall be maintained from grade to 6 ft. 7 inches' height or top of equipment, whichever is greater, minimum of 36 inches wide (18" on each side of center line of meter enclosure) to allow easy and safe access for reading and testing.

METER LOCATION – INDOOR COMMERCIAL: When the meter installation requires that they be placed indoors, the meters must be grouped together in a meter room furnished by the customer that is located on the first floor. KUA shall have access to the meter rooms at all times for reading, testing and servicing the equipment. When meters are located in areas that can be locked, the customer shall make arrangements such that KUA shall have access to the meters at all times. A provided key lock box is acceptable.

METER ROOM REQUIREMENTS: Meters installed inside shall be in a clean, dry, lighted, safe place and be easily accessible. They shall not be located in rest rooms, dressing rooms, bedrooms, kitchens, ventilating or elevator shafts, boiler rooms, laundry rooms, hallways, etc. The meter location must also be free of any other safety type hazard locations.

Using meter rooms for storage or other purposes which cause a degradation in ease of access or adequacy of workspace shall not be allowed. Failure to maintain a safe accessible location for meters shall require that they be relocated to an appropriate location at the customer's expense.

METER IDENTIFICATION ON MULTI-OCCUPANCY BUILDINGS: On multi-occupancy buildings, all meter sockets, all individual service disconnect switches, and the main gang meter service disconnect switches shall be plainly and permanently marked with numbers and/or letters by the customer so as to indicate the building address and unit being served. The markings must be either plastic nameplates or embossed metal tags at least ½" high. If grouped meters are within enclosed meter room, additional labeling is required on the door. KUA does not assumed any responsibility for inspecting the customer's equipment or the accuracy

of matching premise location as indicated on the meter socket and main service disconnect, but shall have the right to satisfy itself that the service is certified by the local inspection authorities and that it is safe to connect.

INDIVIDUAL METER SOCKET LABELING: Any commercial service (including multi-service apartment units) shall have the meter socket clearly marked with a permanent label, showing the service address. The label must be secured with rivets to ensure that the label cannot be removed. The lettering shall be a minimum one-half inch high and be either an engraved plastic or embossed metal tag. The service address must also be displayed on the building or permanent structure per 911 requirements.

METER HEIGHT: All single or double meter installations shall have a meter height of 48 inches to 66 inches above final grade to the center of the meter. All multi-unit gang meter installations shall be a minimum of 22 inches to the bottom meter and a maximum of 72 inches to the top meter from final grade. The measured meter height shall be taken two feet away from the meter socket.

RELOCATION OF ELECTRIC SERVICE AND METER EQUIPMENT: Whenever it becomes necessary to relocate the service entrance and metering equipment of an existing installation, KUA shall be consulted before such work starts. KUA will attempt to minimize interruption of service during the changeover period. Where applicable, additional charges may be necessary for relocation of or changes to power facilities serving the customer especially if the work is performed at the customer's request and for the customer's convenience.

PULSE METERING: If the customer plans on having an energy management system which utilizes meter output pulses, a request for such metering must be made with KUA upfront. All metering conduits shall be supplied and installed by the contractor/customer.

NO CONNECTIONS AHEAD OF METERING DEVICES: The connection of any customer owned apparatus or device to the service conductors ahead of KUA owned meters or to the meter socket without KUA authorization is expressly forbidden. All 480-volt self-contained meter installations require the installation of a non-fused disconnect switch (provided and installed by the customer) ahead of the meter socket for the safety of KUA's employees. The meter socket, or current transformer cabinet shall not be used as a junction box.

METER SEALS: All enclosures containing un-metered conductors shall be capable of being effectively locked and sealed by KUA. The breaking of seals by other than authorized persons or tampering with KUA meters

and measuring devices is prohibited and may be subject to fines and/or tampering fees. Where KUA detects that the physical facilities have been tampered with so as to cause an unauthorized electric energy usage, KUA may at any time without notice, discontinue the electric energy supply to the customer and remove its meter and other apparatus until such time as the customer has corrected the condition to KUA's satisfaction. To gain access to a sealed meter can, contact Operations at (407) 933-7777 ext. 6604

CURRENT TRANSFORMER METERING: The size of current transformers shall be determined by KUA based on the information provided by the customer. Note that current transformer polarity markings must face the line side of the service.

For single phase services greater than 400A service, current transformers are required. Note that the current transformer will not be mounted in single phase pad-mount transformers due to clearance between phases and ground. A separate enclosure is required for this type of application.

For three phase services greater than 600A service, current transformer is required. KUA prefer method is to mount the applicable current transformer inside the pad-mounted three phase transformer that is dedicated to the individual metered location and place the meter socket on the side of the transformer.

When there are multiple metered services from one transformer and a service requires current transformers, a cabinet mount enclosure must be provided for the current transformers. This cabinet must be painted gray and be of a steel material. A 1.0 inch sch-40 PVC conduit must be installed by the customer from the current transformer cabinet to the approved meter location for termination in the meter enclosure. This distance must not exceed 3 feet. KUA prefers that a non-fused disconnect switch be installed in front of the current transformer metered service when multiple meters are fed from the same transformer and the customer wants to minimize power outages to its tenants when the current transformer meter service is periodically tested.

INDEX FOR METER BASE INSTALLATIONS:

Phases	Service	Service Size Amps	Service Type Volts	Socket Type	Meter Form	Reference Notes
1	Residential	0-200	3 wire 120/240	4 jaw 200-Amps	2S	1
1	Residential	>200-400	3 wire 120/240	4 jaw 320-Amps	2SE	1
1	Residential (CTs)	>400	3 wire 120/240	8 jaw 20-Amps	5S	3
1	Commercial Self-contained	0-200	3 wire 120/240	4 jaw 200-Amps	2S	2
1	Commercial Self-contained	>200-400	3 wire 120/240	4 jaw 320-Amps	2SE	
1	Commercial (CTs)	>400	3 wire 120/240	8 jaw 20-Amps	5S	3
1	Commercial Self-contained	0-200	3 wire 120/208	5 jaw 200-Amps	12S	2

Chart continued on next page

INDEX FOR METER BASE INSTALLATIONS (continued):

Phases	Service	Service Size Amps	Service Type Volts	Socket Type	Meter Form	Reference Notes
3	Commercial Self-contained	0-200	4 wire 120/208Y	7 jaw 200-Amps	15/16S	2
			4 wire 120/240 Delta	7 jaw 200-Amps	15/16S	2, 6
			4 wire 277/480Y	7 jaw 200-Amps	15/16S	2, 5
			4 wire 240/480	7 jaw 200-Amps	15/16S	2, 5, 6
3	Commercial Self-contained	>200-400	4 wire 120/208Y	7 jaw 320-Amps	15/16SE	2, 5, 6
			4 wire 120/240 Delta			
			4 wire 277/480Y			
			4 wire 240/480			
3	Commercial Self-contained	>400-600	4 wire 120/208Y	K-7 600-Amps	15/16K	4, 7
			4 wire 120/240 Delta	K-7 600-Amps	15/16K	4, 6, 7
			4 wire 277/480Y	K-7 600-Amps	15/16K	4, 5, 7
3	Commercial (CTs)	>600	4 wire 120/208Y	13 jaw 20-Amps	8/9S	3
			4 wire 120/240 Delta	13 jaw 20-Amps	8/9S	3, 6
			4 wire 277/480Y	13 jaw 20-Amps	8/9S	3

Note 1 – Residential Bypass:

Residential services do not require a bypass device unless the customer requires one.

Note 2 – Bypass:

All self-contained commercial service except for the K-4 and K-7 socket type shall incorporate a lever type jaw tension release (make before break), type bypass device. Meter sockets equal to or greater than all Landis & Gyr “HQ” models, Milbank model 1797x, S9551-0 or greater will be accepted. Sockets with aluminum “jaws” will not be permitted.

Services for irrigation, entry gates, small illuminated signs, or non-essential applications 60A or less do not require a bypass lever. Meters that require uninterrupted service as defined by KUA (e.g. traffic/railroad signals, small cell antennas, etc.) shall always incorporate a bypass lever regardless of service size.

Note 3 – CT Service:

CT cabinets should only be used when required due to installation/design restrictions (KUA CT service equipment standard installation will be installed on the transformer). The cabinet must be made out of a steel material and be UL listed. The specific size shall be determined per application by the customer.

CTs will be mounted left to right (ABC) and the WHITE POLARITY DOT will always be toward the INCOMING or LINE SIDE.

The meter socket shall not be greater than three feet from the location of the current transformers (CTs). The meter socket and CTs shall be mounted outside. The meter socket, test switch and CTs shall be purchased from KUA and maintained by KUA. All metering equipment (excluding the meter) shall be mounted between three feet and six feet above finished grade. New CT services can be completed in most cases on a next day basis (provided that all proper documentation and inspection have been approved and received). However, due to workloads, the lead time could be three to four days.

Meter wiring must be in its own conduit. It cannot share conduit with the service wiring. The conduit from the CT location to the meter socket must be 1.0 inch diameter.

It is suggested that the meter division be contacted at the earliest possible date after the installation of the meter center. This will allow for a timely completion of the project to enable the service technicians to complete the service installation and apply voltage.

Note 4 – Three Phase K-Base

This socket type allows for 480 amps continuous up to 600 amps service maximum (intermittent) in a self-contained profile. The K-7 meter socket (UL listed) to be installed must have an internal shield.

Parallel conductor connectors with a wire size range of #6 through 350 MCM are standard with the “K” socket.

Note 5 – 480v Single Phase Service or 480/277v Three Phase Service

A non-fused disconnect is required to be installed before the meter. This enclosure must be capable of being sealed and locked.

Note 6 – High Leg

Reminder that even though the electrical code may require that the HIGH LEG be in the center of the customer’s equipment, it is still required to be on the right side in ALL METER RELATED EQUIPMENT and marked with orange tape.

Note 7 – K-Base Requirement

Must be used if maximum overcurrent protection device is >400 amps. Can be offered if customer anticipates future expansion beyond the rating of 320-amp socket.

DISTRIBUTION CONSTRUCTION STANDARDS

Underground Conduit Standards - Table of Contents

Section S22 Underground Conduit Standards

30	Table of Content
31	General Notes
35	Definition of Terms
36	Primary Riser Conduit Detail
41	Primary Underground Conduit Detail
42	Secondary Underground Conduit Detail
44	Secondary Road Crossing Conduit Detail
46	Riser Conduit Detail for Residential Service
48	Underground Conduit Detail for Residential Service
50	Underground Conduit Detail for Lighting
51	Underground Conduit Placement in Easement
52	Protection of Pad Mount Equipment
53	Conduit Stub-up Layout

For Conduit Inspections
Visit: kua.com/appointment-request-form/

DISTRIBUTION CONSTRUCTION STANDARDS

Underground Conduit Standards - General Notes

1.0. General Notes:

Per the policies of the Kissimmee Utility Authority, all underground distribution systems shall be installed in gray Schedule 40 PVC, gray Schedule 80 PVC, gray HDPE, gray restrained-joint, and/or galvanized rigid steel conduit. Every installation must comply with the National Electric Safety Code (NESC), latest edition. The complete conduit system shall be furnished and installed by the owner/developer of the project.

2.0. Conduit System Guidelines:

2.1. It is the responsibility of the owner/developer to inform the Kissimmee Utility Authority Distribution Engineering Division of the service main breaker size being installed or any special load requirements for both residential type and commercial type projects.

2.2. For all three-phase residential services and single-phase residential services greater than 200 amps, the conduit size shall be at least 3 inches in diameter. It is the responsibility of the owner/developer to contact KUA for conduit size.

2.3. For all commercial services, it is the responsibility of the owner/developer to furnish and install the service conductor and conduit, including all apartments and condo structures regardless of size.

2.4. No conduit shall be installed inside of structural walls or structural foundation, nor under building structures. No meter service stub-ups shall be installed in structural footers or walls.

2.5. There shall be no more than a total of 360 degree bends in a run. There shall not be any back to back conduit bends.

2.6. KUA requires 18" separation vertically and horizontally from all other underground utility systems. In the event that NESC or other applicable standards require more spacing of facilities, the conduit system must be adhered to for such installation.

3.0. Installation Guidelines: The guidelines in which the owner/developer shall adhere to are listed herein.

3.1. There shall not be any concrete around conduits beneath any pad mount equipment.

3.2. When the Contractor pulls in the secondary service wire into the pad mount transformer, the wire extending out of the conduit must be of sufficient length to connect to the transformer bus conductor bars. KUA will not splice conductors installed by the contractor so that it will reach the transformer bus or service cables.

3.3. All electric primary voltage conduits must be brushed out with a wire mandrel, cleaning type mandrel or a short rubber slug mandrel to clean out the conduit. Then, a 2500 lbs. flat woven polyester pull tape (that contains measured distances) shall be pulled into the conduit with a proving mandrel of the proper size for said conduit size. The proving mandrel must be no more than 10% less than the 4" or 6" conduit inner diameter.

3.4. All secondary voltage conduits (except house services) shall have pull string installed.

3.5. All secondary voltage service conduits shall be stubbed out from the running line (KUA power lines running parallel to the roadside property lines) a distance of at least ten (10) feet. These stub ups must be used when extending the conduit system to the individual meter service location.

3.6. All conduit stub-markers shall extend 24" vertically above finished grade. The flat woven pull tape shall be secured to all primary and secondary conduit stub-ups. Secure marking tape from the end of the conduit stub out to the top of the conduit stub-marker. Secondary service stubs are not required to have pull tape.

3.7. Conduits located in transformers and secondary junction boxes shall be even with the top of the concrete pads when the customer is required to install cable. Otherwise, extend conduits 24" above the top of the concrete pad and duct tape them together. The electrical contractor will make all conduit adjustments before the low voltage conductors are installed.

3.8. The bottom of all transformer pads and junction box pads and/or sites shall be leveled at grade to fit the proposed equipment. Before KUA installs any electric infrastructure, the developer must sign a final grade sheet that states that the equipment is at the proper grade, including any conduit in swells going to the meter service location.

3.9. All conduit shall be installed in accordance with the Kissimmee Utility Authority's conduit layout plan for said owner/developer project. It is the responsibility of the owner/developer to install all conduit, and 2500 lbs. flat woven polyester pull tape as called forth on the conduit layout plans.

3.10. All conduits installed for KUA future primary and secondary conductors must have traceable material installed, exposed at origin for contact point.

3.11. Property corners and grade stakes shall be installed by a registered land surveyor. A final stake shall be installed at each equipment location. These stakes shall remain for the life of the construction project. On commercial projects, surveying of curbing and sidewalks must also be marked for field reference before any conduit is placed in the field.

3.12. The completed conduit system will be inspected by KUA. When all the conduit system installation requirements are met, the owner/developer shall request an inspection. A representative of the installation contractor is required to be at the site during the inspection. The inspection must be requested 24 hours in advance. For arranging a conduit inspection, visit: kua.com/appointment-request-form/.

3.13 Ideally, conduit depth should be verified by KUA's conduit inspector prior to backfilling. However, if the trench must be backfilled prior to inspection, site pipes are required at least every 25 feet along the length of the conduit run. The KUA inspector will make ample tests to determine if the installation is correct. The KUA inspector has the authority of requesting the conduit to be uncovered if he/she deems it necessary and to require additional survey stakes be placed to verify that the conduit system has been placed in the proper location.

3.14 The tops of all 4" and 6" galvanized rigid steel conduit bends must be 12" below final grade and must extend 3 feet with gray Schedule 40 PVC conduit. Note that this requirement doesn't apply for riser pole construction.

3.15 There shall be no more than two (2) conduit runs on a riser pole.

3.16 Galvanized Rigid Steel long sweep conduit bends must be installed and used for all 4" and 6" conduit system. All other conduit systems can use standard sweep Schedule 40 90 degree per runs under 300 feet elbows and long sweep 90 degree elbows for runs over 300 feet.

3.17 For multi-service buildings, all services must be accessible by KUA vehicles. No backyard meter service locations allowed on any townhome, condo structures, or apartment buildings.

3.18 All conduits to be added to KUA electric equipment after such equipment has already been installed, whether energized or not, shall be supervised by qualified KUA individuals capable of accessing energized equipment. No new conduit shall be pushed into energized electric equipment.

3.19 Prior to installing conduit stubs, it is the responsibility of the contractor to notify engineering and/or conduit inspector of the number of conduits and the conduit size in which he intends to place in any three phase equipment. Any special requirements related to secondary bar size must be indicated upfront.

3.20 All conduit located in public or private roadways shall be a minimum of 42" below final road grade. Crossing inspections should generally occur prior to paving and installing curbing. KUA's conduit inspector will need to verify the depth at the proposed curb.

3.21 All secondary conduit located on private property shall be a minimum of 24" below curb or final grade (whichever is lower) unless otherwise specified.

3.22 All primary conduit located on private property shall be a minimum of 36" below curb or final grade, (whichever is lower) unless otherwise specified.

3.23 Where erosion is an issue and the KUA's equipment grade is lower than the existing grade is that will eventually be brought down when the house pad is built, 4 feet of silt fence will need to be placed 3 feet behind transformer and/or 2 feet of sod will need to be installed around KUA's equipment pad.

3.24 No tree vegetation shall be planted within 20 feet of KUA's overhead power lines.

4.0. DISCLAIMER: KUA makes no representation or warranty to the accuracy of the base map as in the conduit crossing plan and/or conduit layout plan that is provided to the developer for a particular project. The land base has been compiled from the most accurate sources available. The electric facilities shown are approximate & for KUA's own use & may not be suitable for others. KUA assumes no responsibility or liability to others in the use of such plans and/or document. The base maps are a graphic representation only & are not intended to be a legal or survey document.

DISTRIBUTION CONSTRUCTION STANDARDS

Definition of Terms

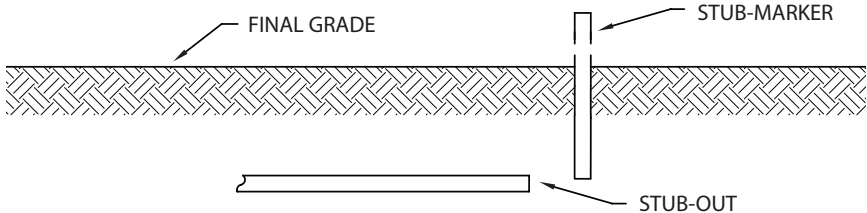
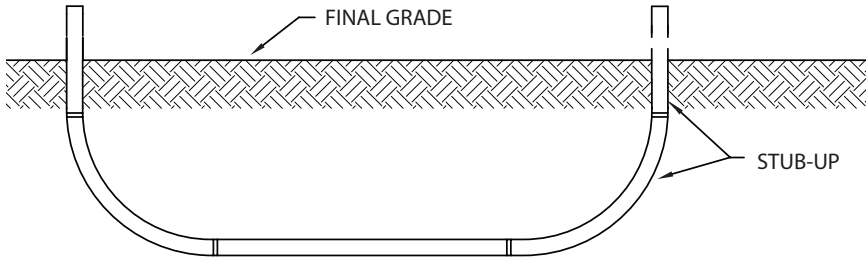

DISTRIBUTION CONSTRUCTION STANDARDS

3 Phase Primary Riser Conduit Detail for 4/0 AL Conductor or Greater

Note: All riser pole conduit shall be supplied by the owner/developer and must be on the job site. The owner/developer shall install the bottom joint of galvanized rigid steel conduit and KUA will install the top two (2) joints. The bottom joint of conduit and 90 degree elbow shall be installed by the developer after KUA installs the riser pole. The developer must also supply six (6) two hole rigid steel straps (2 straps per 10 ft. joint). Ground clamp will be provided and installed by KUA. Refer to General Notes of this document regarding conduit depths.

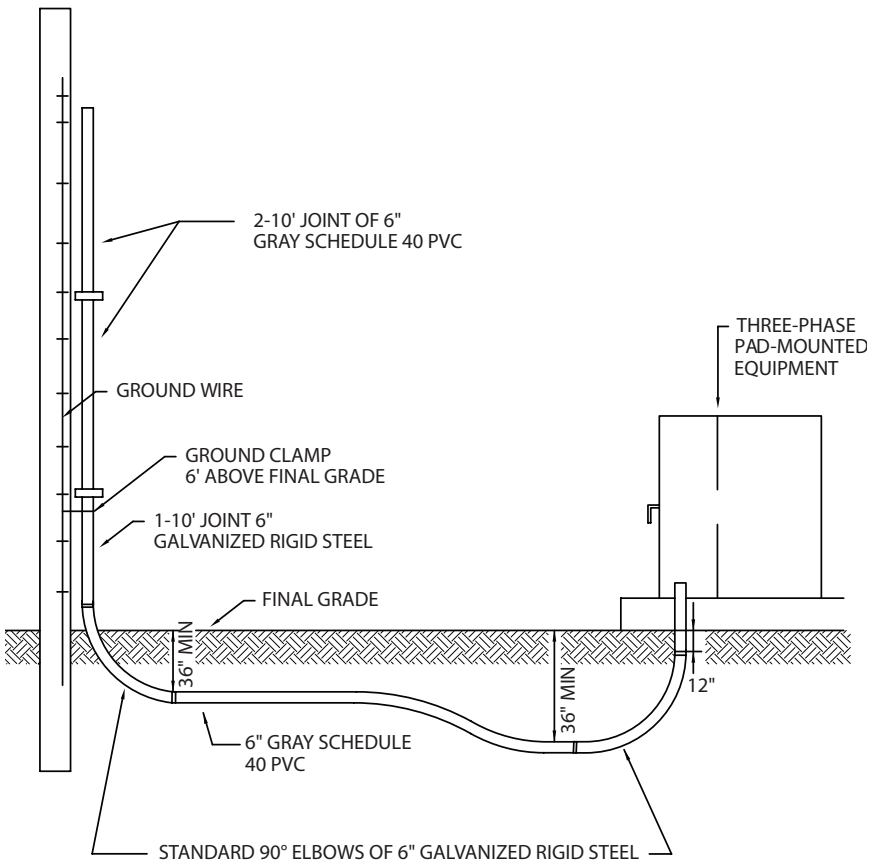

DISTRIBUTION CONSTRUCTION STANDARDS

3 Phase Primary Riser Conduit Detail for Conductors Smaller Than 4/0

Note: All riser pole conduit shall be supplied by the owner/developer and must be on the job site. The owner/developer shall install the bottom joint of galvanized rigid steel conduit and KUA will install the top two (2) joints. The developer must also supply six (6) two hole rigid steel straps (2 straps per 10 ft. joint). Ground clamp will be provided and installed by KUA. Refer to General Notes of this document regarding conduit depths.

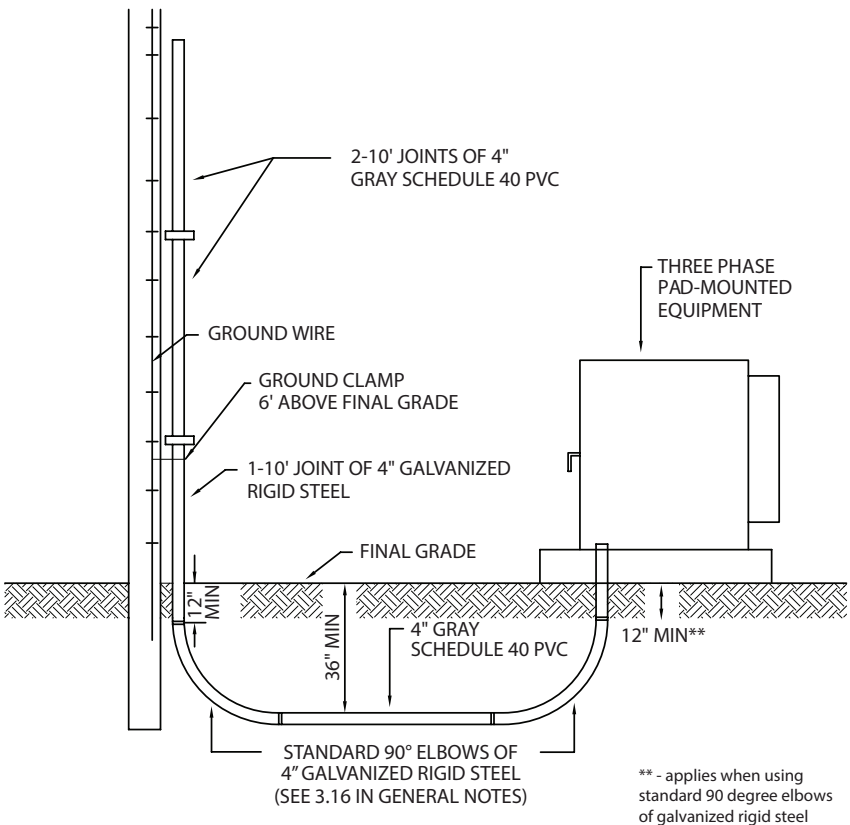

DISTRIBUTION CONSTRUCTION STANDARDS

3 Phase Primary Underground Conduit for Conductors 4/0 or Greater

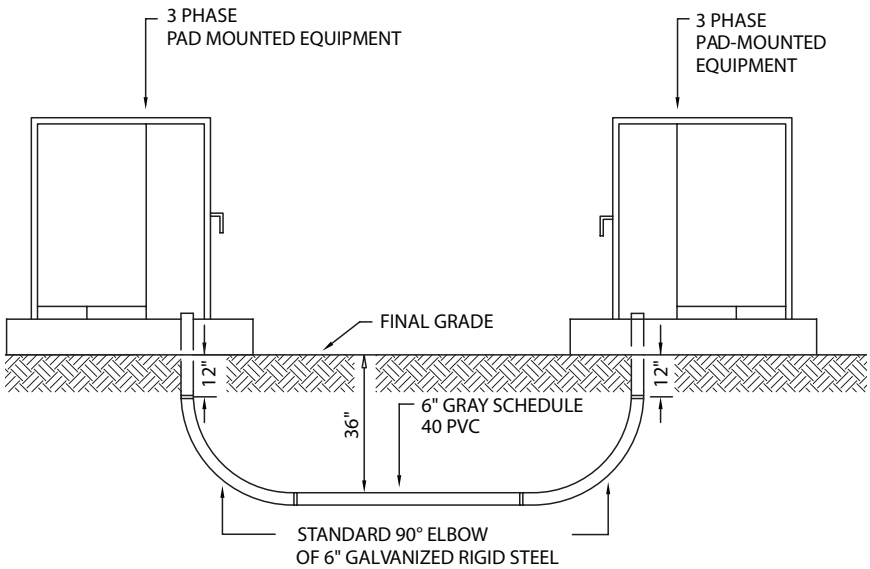

DISTRIBUTION CONSTRUCTION STANDARDS

3 Phase Primary Underground Conduit for Conductors Smaller Than 4/0

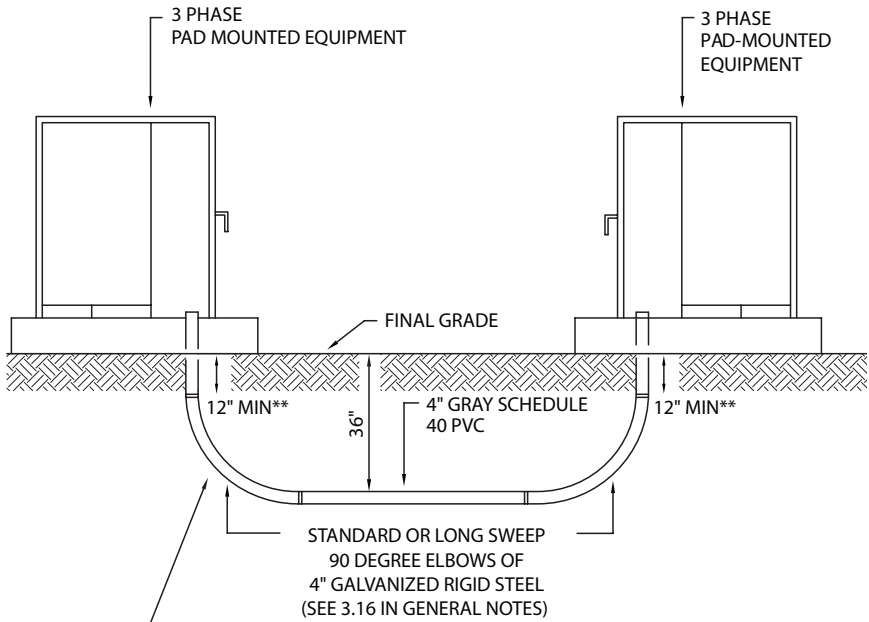

ADDITIONAL DEPTH IS REQUIRED FOR PLACEMENT OF LONG SWEEP 90 DEGREE ELBOWS.

** - applies when using standard 90 degree elbows of galvanized rigid steel

DISTRIBUTION CONSTRUCTION STANDARDS

1 Phase Primary Underground Conduit Detail

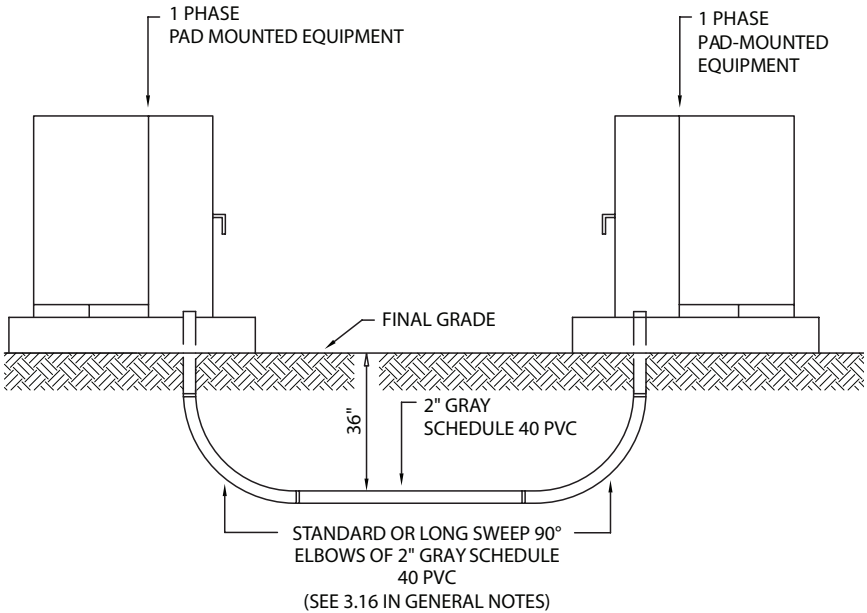

DISTRIBUTION CONSTRUCTION STANDARDS

3 Phase Secondary Underground Conduit Detail

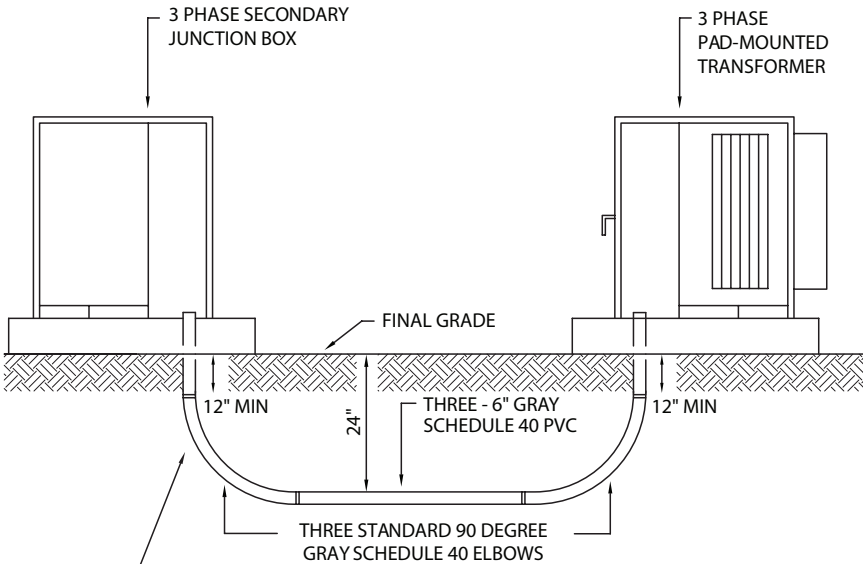

ADDITIONAL DEPTH IS REQUIRED FOR PLACEMENT OF LONG SWEEP 90 DEGREE ELBOWS.

COORDINATE WITH KUA BEFORE INSTALLING THIS APPLICATION AS ADDITIONAL REQUIREMENTS MAY BE REQUIRED DEPENDING ON PROJECT CONDITIONS.

DISTRIBUTION CONSTRUCTION STANDARDS

1 Phase Secondary Underground Conduit Detail

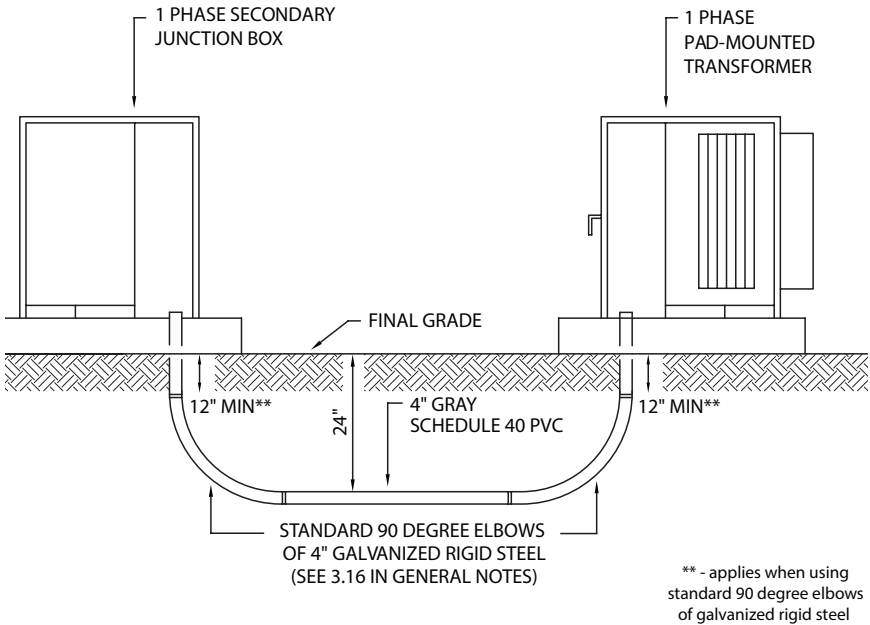

DISTRIBUTION CONSTRUCTION STANDARDS

3 Phase Secondary Road Crossing Conduit Detail

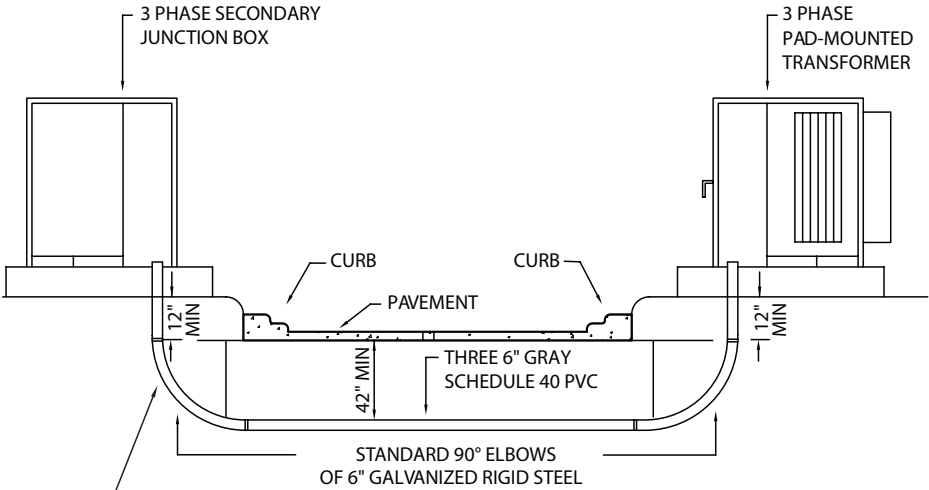

ADDITIONAL DEPTH IS REQUIRED FOR PLACEMENT OF LONG SWEEP 90 DEGREE ELBOWS.

COORDINATE WITH KUA BEFORE INSTALLING THIS APPLICATION AS ADDITIONAL REQUIREMENTS MAY BE REQUIRED DEPENDING ON PROJECT CONDITIONS.

DISTRIBUTION CONSTRUCTION STANDARDS

1 Phase Secondary Road Crossing Conduit Detail

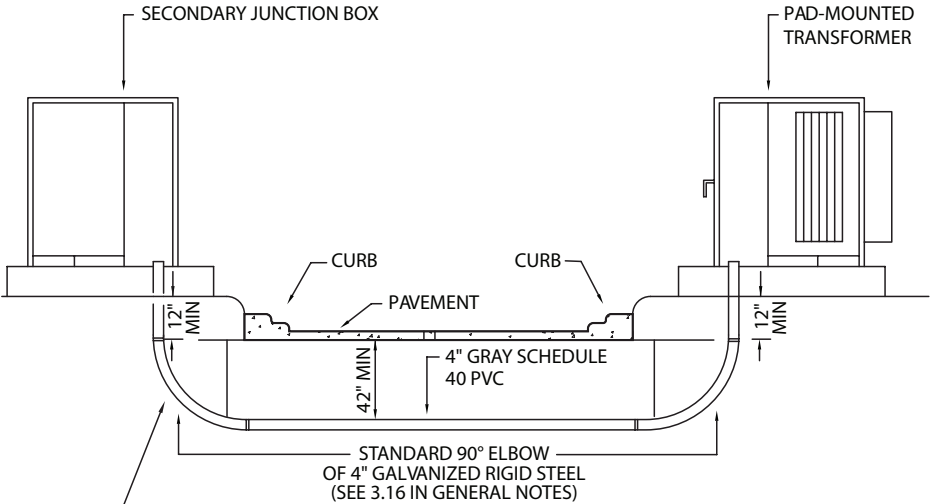

ADDITIONAL DEPTH IS REQUIRED FOR PLACEMENT OF LONG SWEEP 90 DEGREE ELBOWS.

COORDINATE WITH KUA BEFORE INSTALLING THIS APPLICATION AS ADDITIONAL REQUIREMENTS MAY BE REQUIRED DEPENDING ON PROJECT CONDITIONS.

DISTRIBUTION CONSTRUCTION STANDARDS

Riser Conduit Detail for Residential Service (200 Amps)

Note: All riser pole conduit shall be supplied by the owner/developer and must be on the job site. The owner/developer shall install the bottom joint of galvanized rigid steel conduit and KUA will install the top two (2) joints. The bottom joint of conduit and 90 degree elbow shall be installed by the developer after KUA installs the riser pole. The developer must also supply six (6) two hole rigid steel straps (2 straps per 10 ft. joint). Ground clamp will be provided and installed by KUA. Refer to General Notes of this document regarding conduit depths.

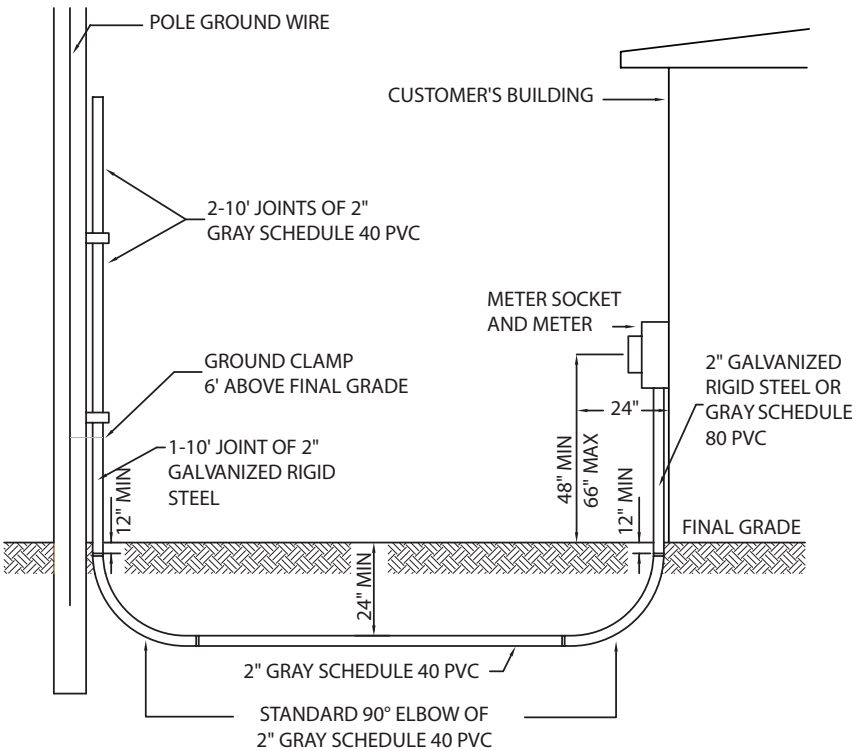

DISTRIBUTION CONSTRUCTION STANDARDS

Riser Conduit Detail for Residential Service (Greater Than 200 Amps)

Note: All riser pole conduit shall be supplied by the owner/developer and must be on the job site. The owner/developer shall install the bottom joint of galvanized rigid steel conduit and KUA will install the top two (2) joints. The bottom joint of conduit and 90 degree elbow shall be installed by the developer after KUA installs the riser pole. The developer must also supply six (6) two hole rigid steel straps (2 straps per 10 ft. joint). Ground clamp will be provided and installed by KUA. Refer to General Notes of this document regarding conduit depths.

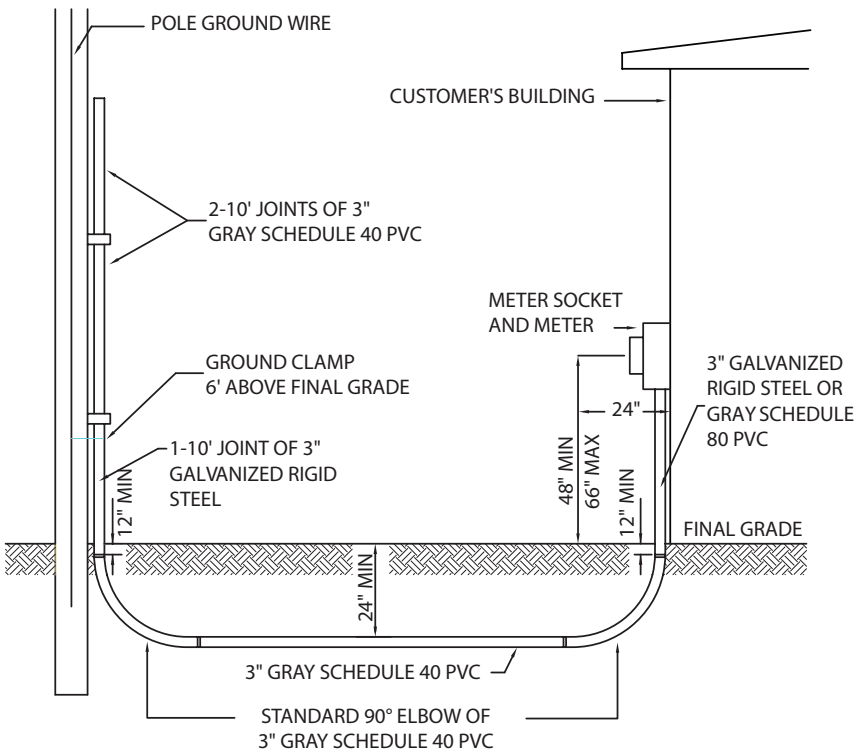

DISTRIBUTION CONSTRUCTION STANDARDS

Conduit Detail for Residential Service (200 Amp)

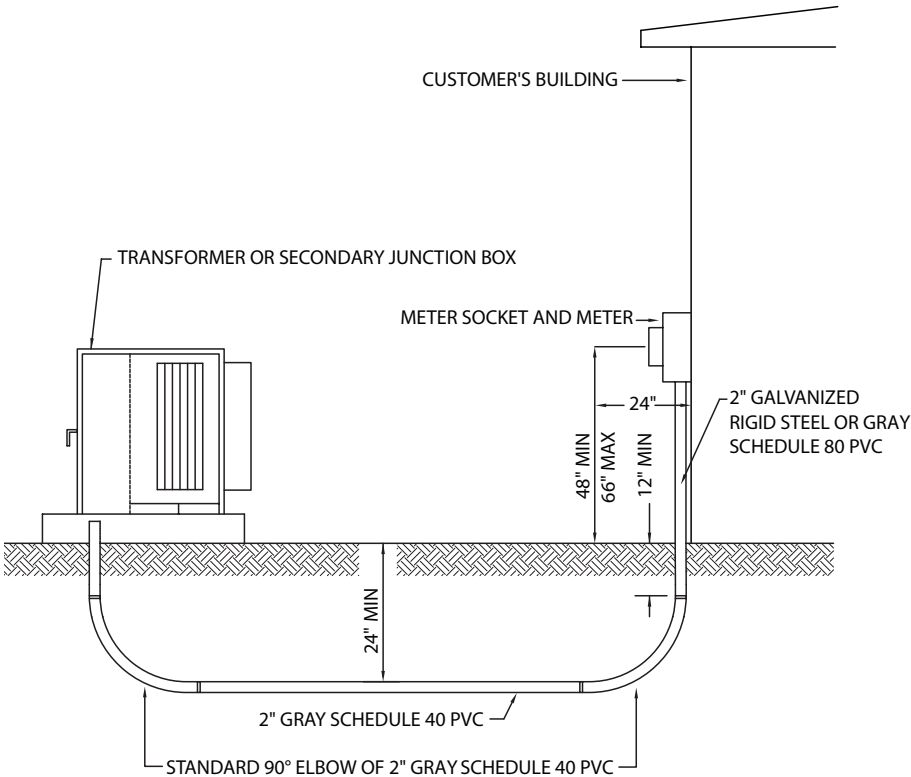

DISTRIBUTION CONSTRUCTION STANDARDS

Conduit Detail for Residential Service (Greater Than 200 Amp)

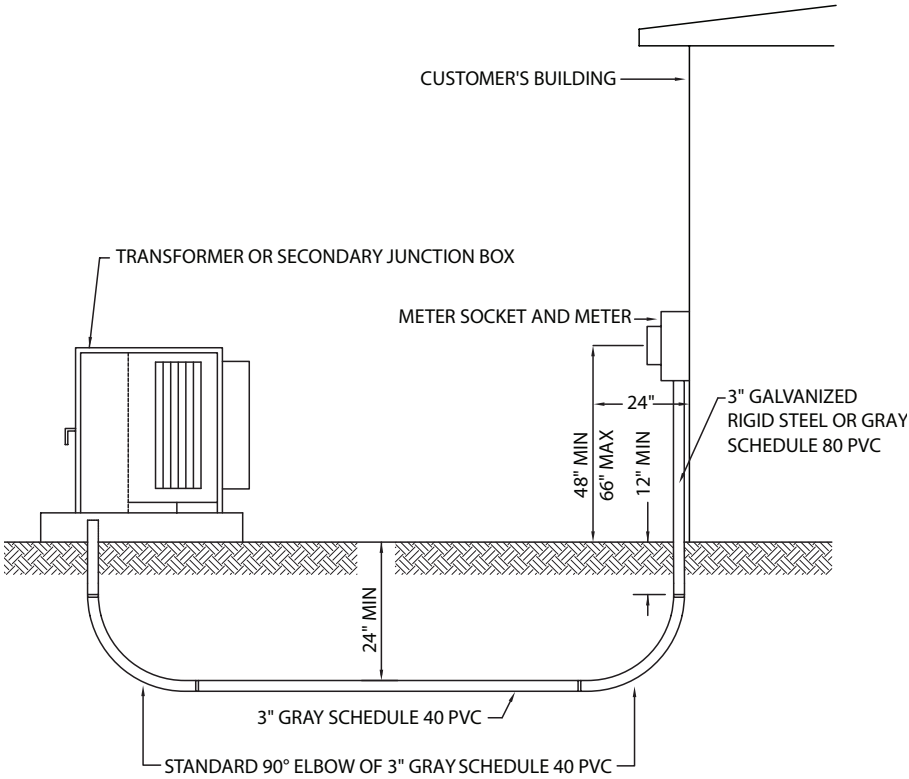

DISTRIBUTION CONSTRUCTION STANDARDS

Conduit Detail for Lighting

Note: All area lighting conduit must be 2" Schedule 40 Gray PVC. Conduit runs within the right of way shall be installed deeper per requirements of Osceola County or the City of Kissimmee. Refer to General Notes of this document regarding conduit depths

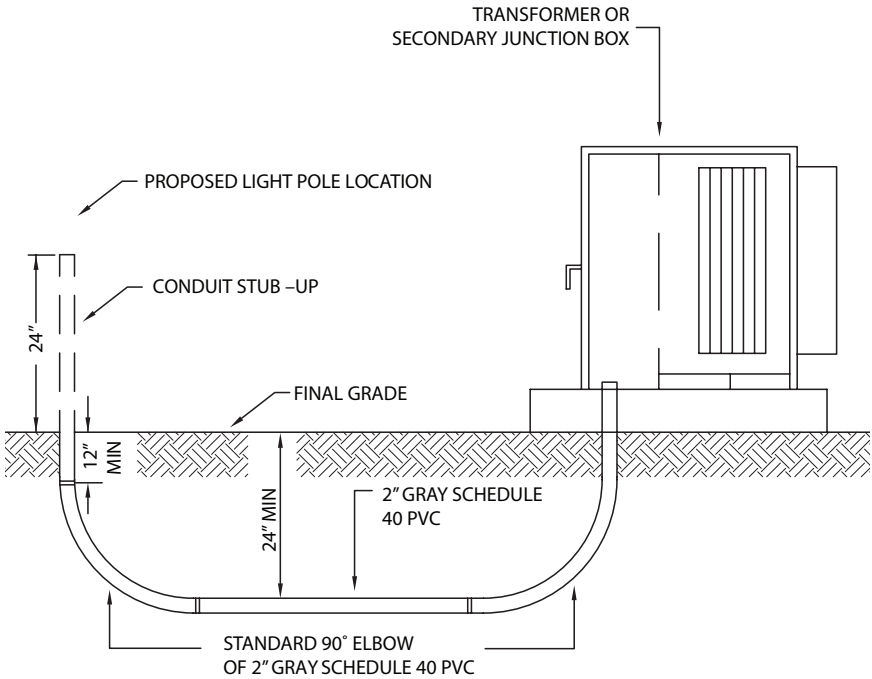

DISTRIBUTION CONSTRUCTION STANDARDS

Conduit Placement in Utility Easement

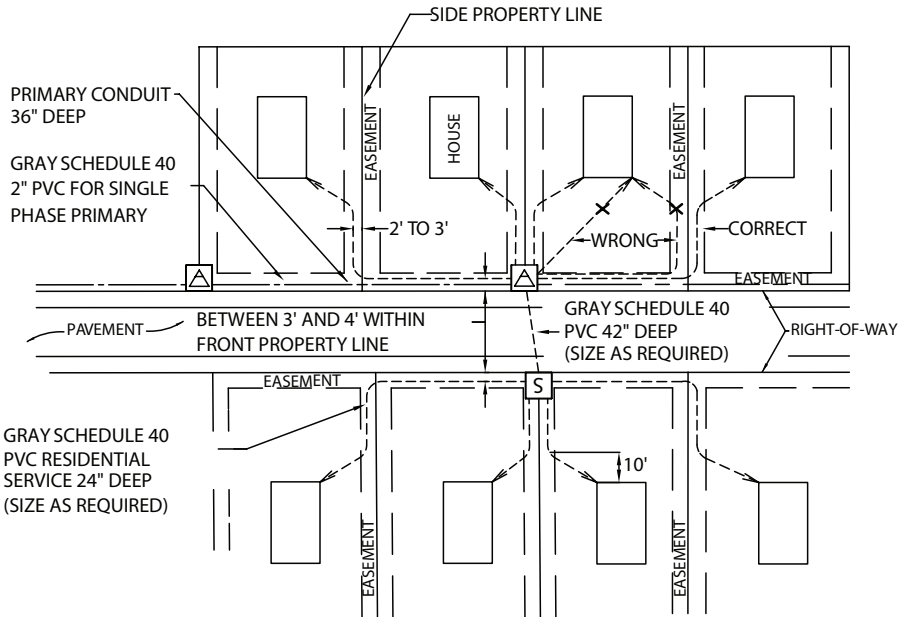

Conduit Location in Regards to Utility:

The typical utility easement that KUA request from the owner/developer shall be ten (10) feet on the roadside of the property & five (5) on the sides of the property; Seven and a half (7.5) feet on the rear of the property may also be required. KUA uses the utility easements for building the electric infrastructure to the property for electric service.

1. All conduits must be installed along the lot lines within the right of ways or plotted utility easements. All transformers & junction boxes shall be centered on the side lot line.
2. Conduit that encroaches on private property outside of easements & dedicated right of ways shall be relocated by the owner/contractor/developer. All relocation work along with lowering conduits shall be paid by the owner/contractor/developer.
3. Conduits shall remain in the easement until 10 feet in front of the building. The conduits can then angle over out of the easement to the service location.
4. All service locations shall be installed per KUA's project layout. If a line extension contract is required for installing transformers & junction boxes, the line extension cost shall be paid by the owner/contractor/developer of the project.

DISTRIBUTION CONSTRUCTION STANDARDS

Protection of Pad Mounted Equipment

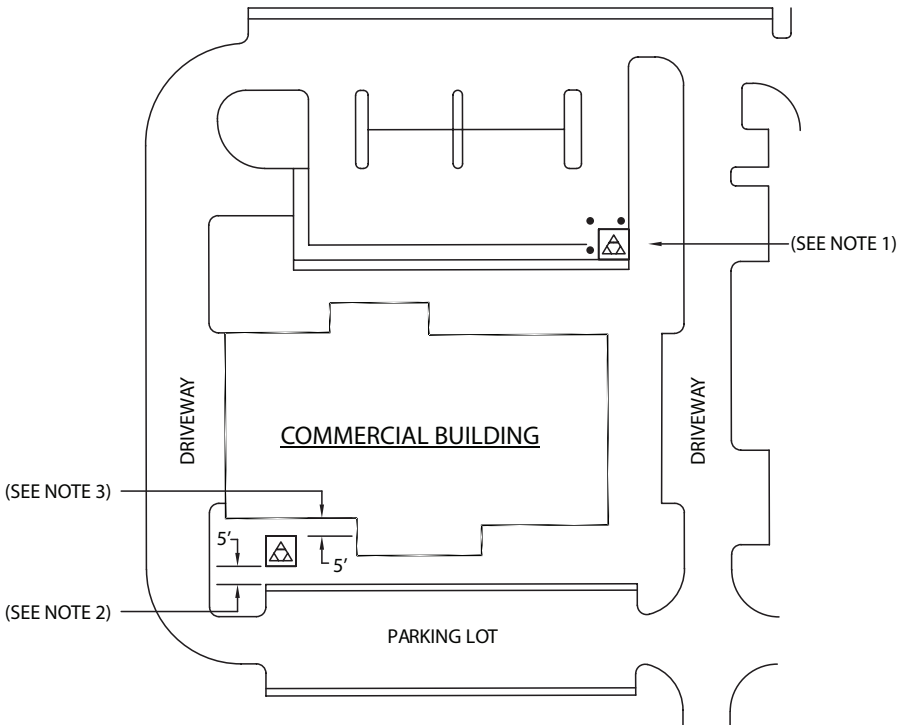

Protection of Transformers and Junction Boxes: The transformer and/or junction box shall be protected by the following means:

1. Six-inch iron pipe guards buried 4 feet below finished grade with 12" of concrete around the pipe and the pipe poured full of concrete and rounded on top. These pipes must be placed on all traffic bearing sides of the transformer and/or junction box with 4' extended vertically above grade. KUA's representative will determine the exact number and location of the pipe guards.
2. A minimum distance of 5 feet from the back edge of the parking curbs to any portion of the transformer and /or junction box. The back of transformer shall have at least 5 ft. horizontal clearance and no obstructed vertical clearance.
3. A minimum of 5 feet clearance shall be maintained between building structure overhang and pad mounted equipment.
4. The transformer and/or junction boxes will not be located in any location that cannot be easily accessed by KUA vehicles for maintenance purposes.

DISTRIBUTION CONSTRUCTION STANDARDS

Secondary Junction Box Conduit Stub-up Layout

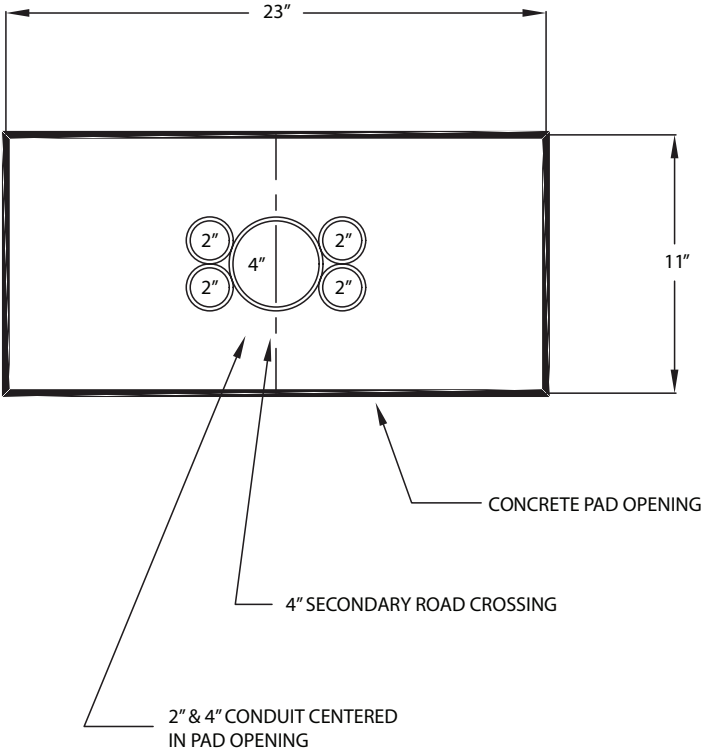

Conduit sizes may vary with design. If conduit number and size are different than as shown, please contact the Project Engineer.

DISTRIBUTION CONSTRUCTION STANDARDS

Primary Junction Box Conduit Stub-up Layout

Typical For:

Single Phase Primary Junction Box (Type 3)

Three Phase Primary Junction Box (Type 4)

Three Phase Primary Fused Junction Box (Type 6 or Type 6A)

Three Phase Primary Fused Junction Box (Type 7 or Type 7A)

Three Phase Primary Metering Junction Box (Type 12)

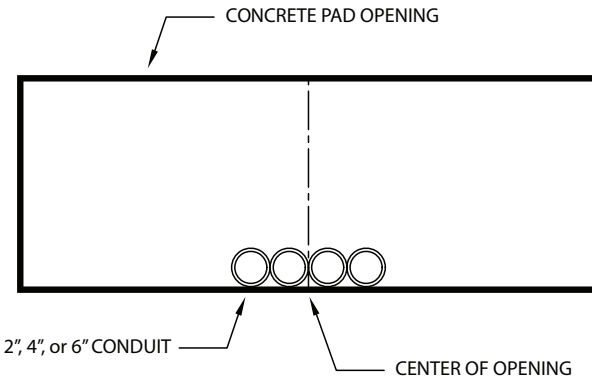

Conduit sizes may vary with design. If conduit number and size are different than as shown, please contact the Project Engineer.

DISTRIBUTION CONSTRUCTION STANDARDS

Single Phase Transformer Conduit Stub-up Layout

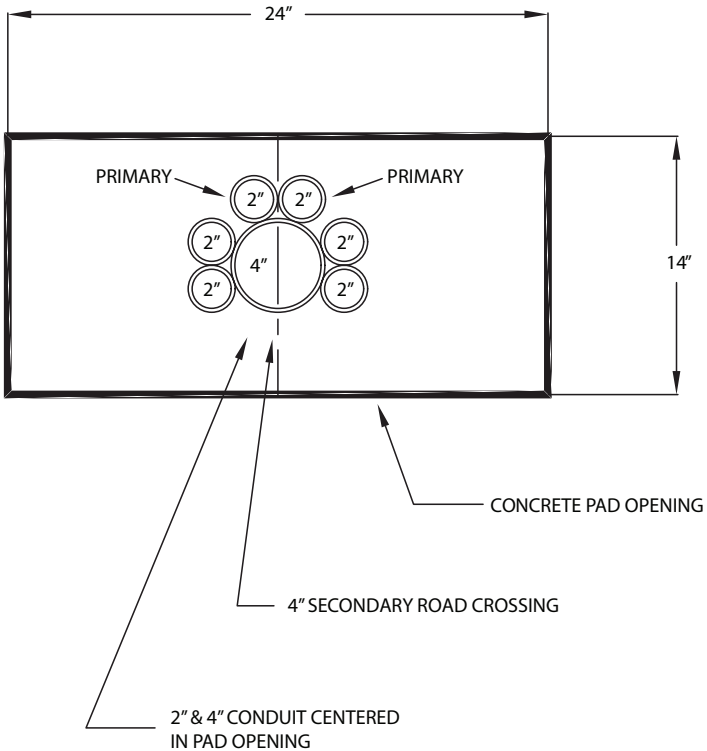

Conduit sizes may vary with design. If conduit number and size are different than as shown, please contact the Project Engineer.

DISTRIBUTION CONSTRUCTION STANDARDS

Single Phase Transformer (167 or 250kVA)

Conduit Stub-up Layout

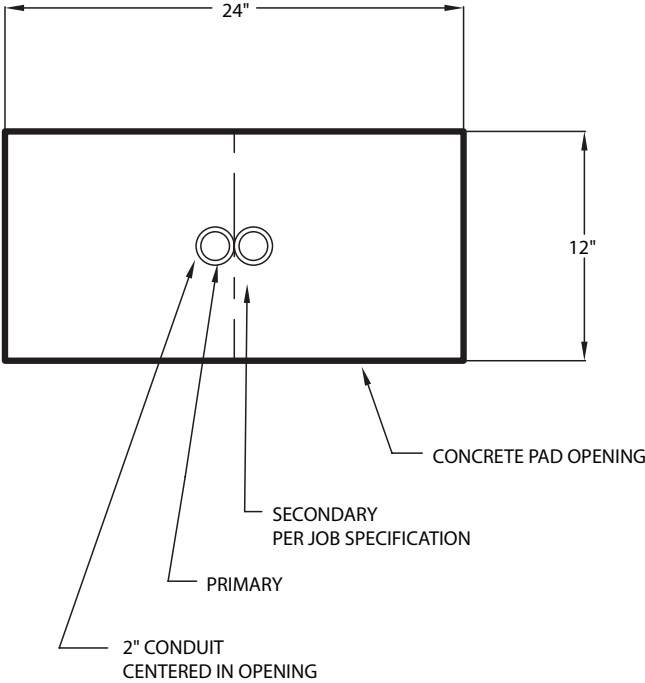

Conduit sizes may vary with design. If conduit number and size are different than as shown, please contact the Project Engineer.

DISTRIBUTION CONSTRUCTION STANDARDS

Three Phase Transformer Conduit Stub-up Layout (500kVA or Less)

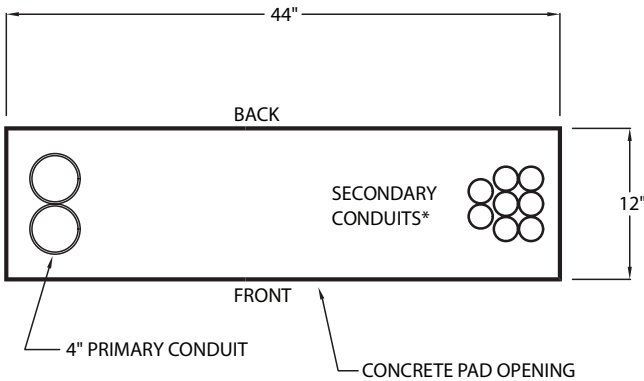

*-8 MAXIMUM CONDUITS PER JOB SPECIFICATION.

Conduit sizes may vary with design. If conduit number and size are different than as shown, please contact the Project Engineer.

DISTRIBUTION CONSTRUCTION STANDARDS

Three Phase Transformer Conduit Stub-up Layout (750kVA or Greater)

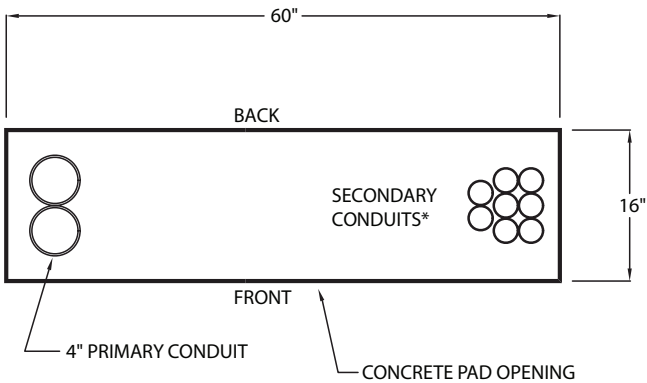

*-8 MAXIMUM CONDUITS PER JOB SPECIFICATION.

Conduit sizes may vary with design. If conduit number and size are different than as shown, please contact the Project Engineer.

DISTRIBUTION CONSTRUCTION STANDARDS

Type 10 Switchgear Conduit Stub-up Layout

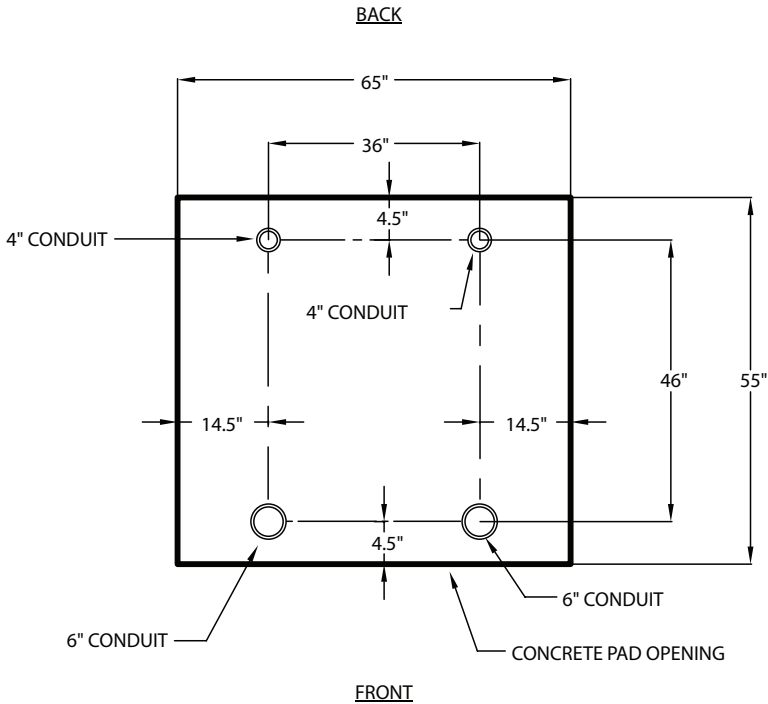

Conduit sizes may vary with design. If conduit number and size are different than as shown, please contact the Project Engineer.

DISTRIBUTION CONSTRUCTION STANDARDS

Type 11 Switchgear Conduit Stub-up Layout

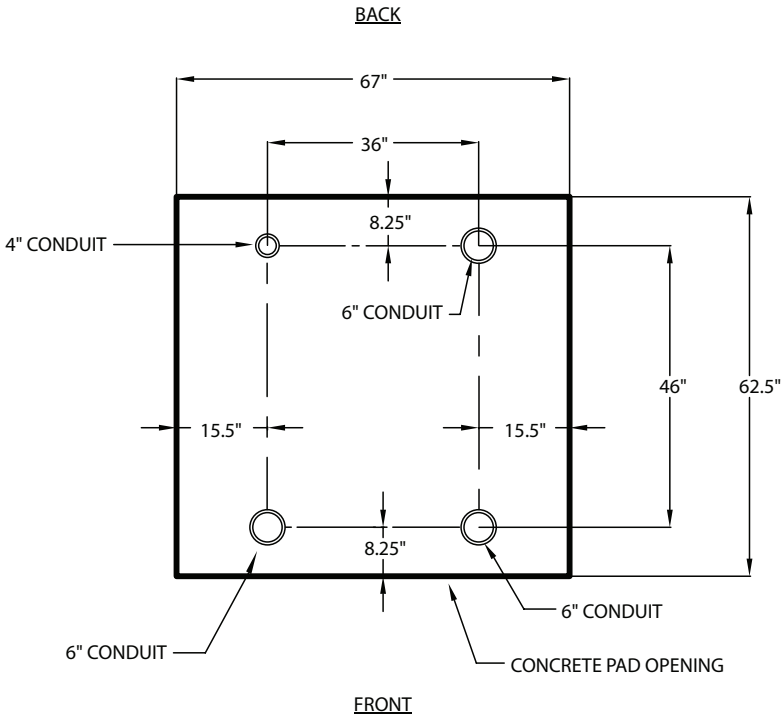

Conduit sizes may vary with design. If conduit number and size are different than as shown, please contact the Project Engineer.

DISTRIBUTION CONSTRUCTION STANDARDS

Type 13 and 14 Switchgear Conduit Stub-up Layout

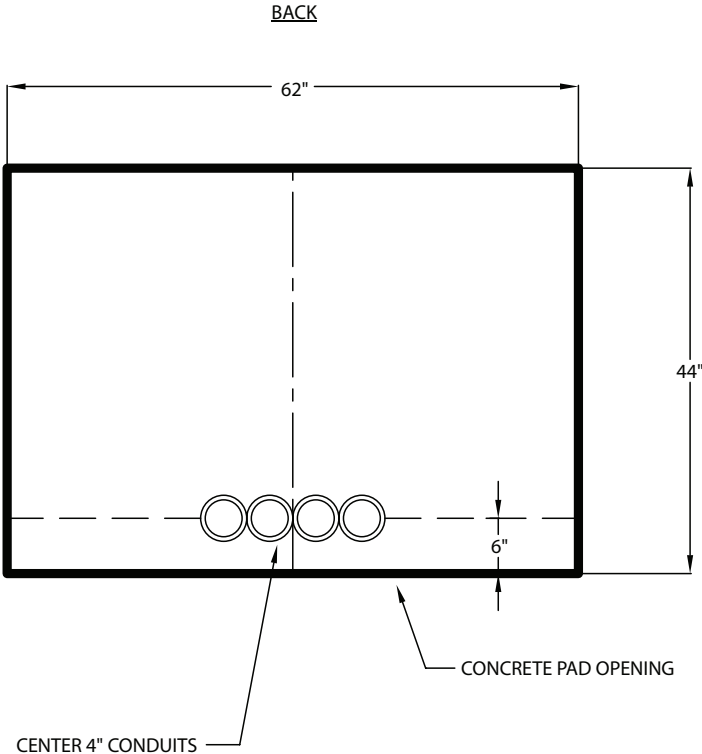

Conduit sizes may vary with design. If conduit number and size are different than as shown, please contact the Project Engineer.

DISTRIBUTION CONSTRUCTION STANDARDS

Type 15 Switchgear Conduit Stub-up Layout

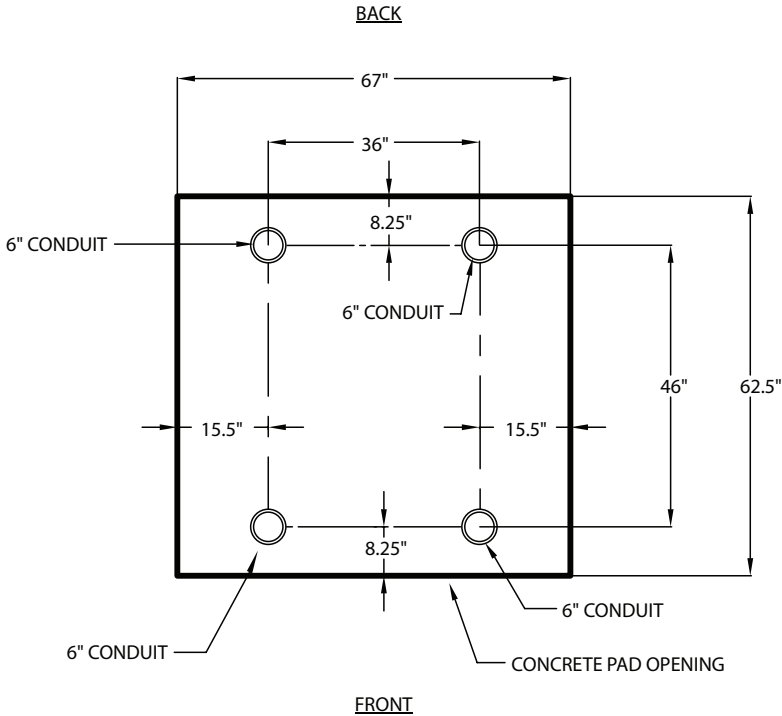

Conduit sizes may vary with design. If conduit number and size are different than as shown, please contact the Project Engineer.

DISTRIBUTION CONSTRUCTION STANDARDS

Open Delta Conduit Stub-up Layout

OPEN DELTA

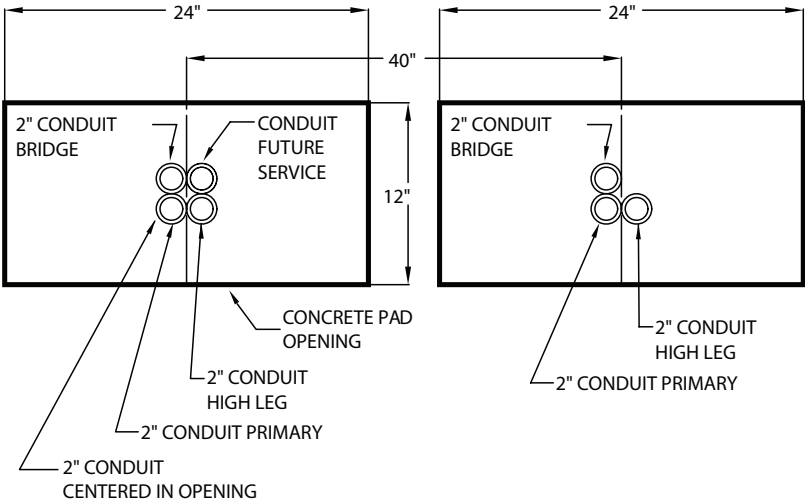

Conduit sizes may vary with design. If conduit number and size are different than as shown, please contact the Project Engineer.



1701 W. Carroll St.
Kissimmee, FL 34741
(407) 933-7777

kua.com/builders-contractors-assistance-and-engineering-forms/